



m. marcus  
architectural hardware

FLUSH PULLS & SLIDING DOOR HARDWARE



**Heritage Brass**<sup>®</sup>  
SOLID BRASS DOOR FURNITURE

All items on this page are available in all finishes **ME** **SB** **SN** **AT** **SC** **PB** **PC** **BLK**

Shown here in Antique Finish



Coding for 40mm Backset:

- RD2308-40-PB
- RD2308-40-PC
- RD2308-40-SC
- RD2308-40-SN
- RD2308-40-AT
- RD2308-40-SB
- RD2308-40-MB
- RD2308-40-BLK

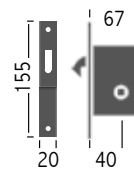

Coding for 50mm Backset:

- RD2308-50-PB
- RD2308-50-PC
- RD2308-50-SC
- RD2308-50-SN
- RD2308-50-AT
- RD2308-50-SB
- RD2308-50-MB
- RD2308-50-BLK

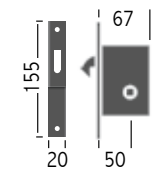

Round design shown here in Antique Finish

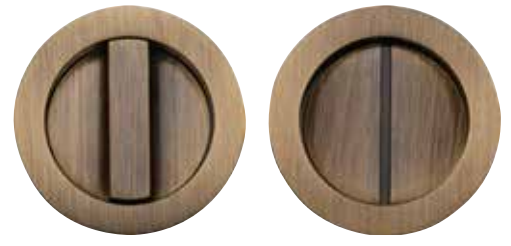

Turn side view  
Ø 57mm

Release side view  
Ø 57mm

Boxed set comprises: Lock - Round Flush Handle Set - Finger Pull

Shown here in Satin Brass Finish

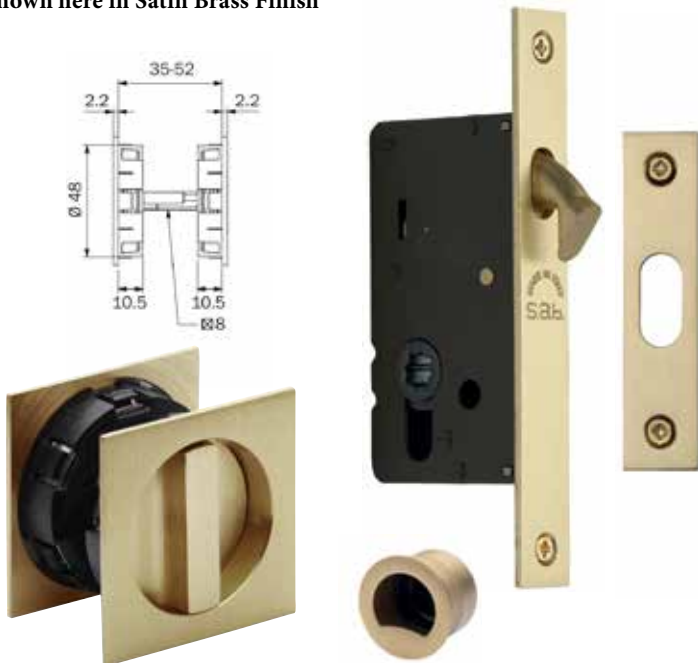

Coding for 40mm Backset:

- SQ2308-40-PB
- SQ2308-40-PC
- SQ2308-40-SC
- SQ2308-40-SN
- SQ2308-40-AT
- SQ2308-40-SB
- SQ2308-40-MB
- SQ2308-40-BLK

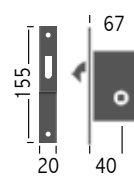

Coding for 50mm Backset:

- SQ2308-50-PB
- SQ2308-50-PC
- SQ2308-50-SC
- SQ2308-50-SN
- SQ2308-50-AT
- SQ2308-50-SB
- SQ2308-50-MB
- SQ2308-50-BLK

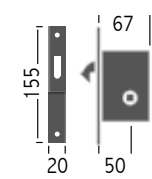

Square design shown here in Satin Brass Finish

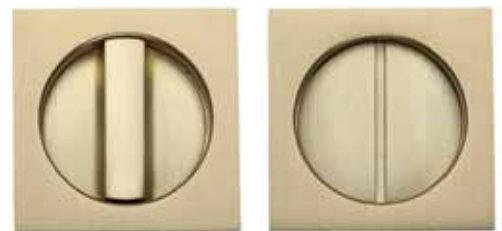

Turn side view  
55 x 55mm

Release side view  
55 x 55mm

Boxed set comprises: Lock - Square Flush Handle Set - Finger Pull

Flush Pulls



**RD2322**  
Round Flush Pull  
Diameter 57mm

Supplied as pairs



**SQ2327**  
Square Flush Pull  
55 x 55mm

Supplied as pairs



**RD373**  
Pull Ring

Supplied as singles

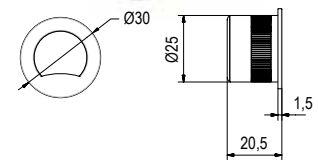

MADE IN ITALY  
ITALIAN SLIDING DOOR HARDWARE

All items on this page are available in finishes **ME** **SB** **SN** **AT** **SC** **PE** **PC** **BLK**

**Round design shown here in Matt Black Finish**



Boxed set comprises: Lock & Striking plate - Round Flush Handle Set - Finger Pull

**Square design shown here in Satin Nickel Finish**

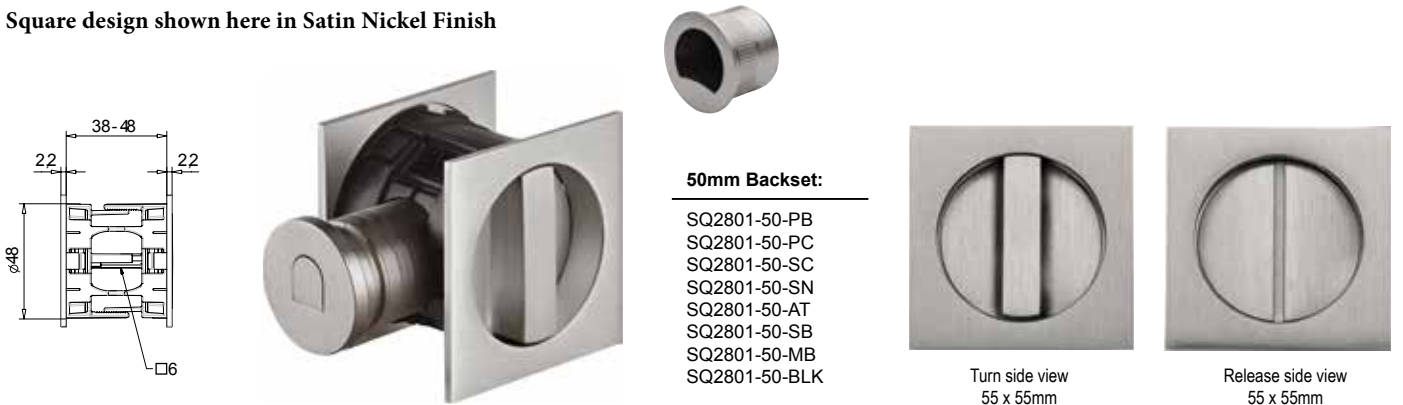

Boxed set comprises: Lock & Striking plate - Square Flush Handle Set - Finger Pull

**Latch Tubular Hook-Bolt Lock**

Shown in Polished Chrome Finish



Latch Tubular Hook-Bolt Lock  
Supplied each within the boxed sets

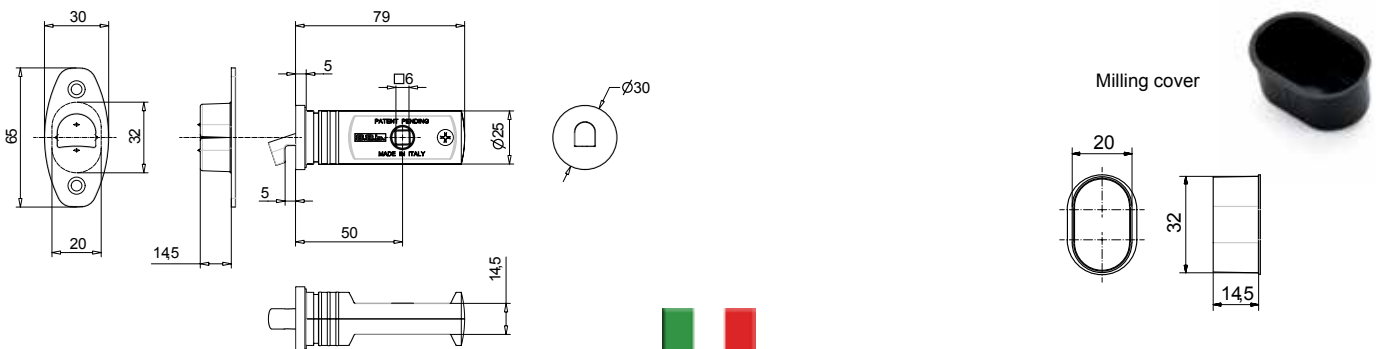

MADE IN ITALY

ITALIAN SLIDING DOOR HARDWARE

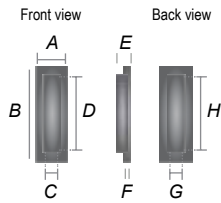

**C1877**  
Flush Pull Privacy

Note:  
The recess measurement required to fit this item is taken from the back

| ITEM  | A  | B   | C  | D   | E  | F | G  | H   |
|-------|----|-----|----|-----|----|---|----|-----|
| C1877 | 57 | 197 | 40 | 161 | 10 | 2 | 50 | 172 |

The C1877 Flush Pull Privacy sets are supplied complete with a sliding door lock in matching finish

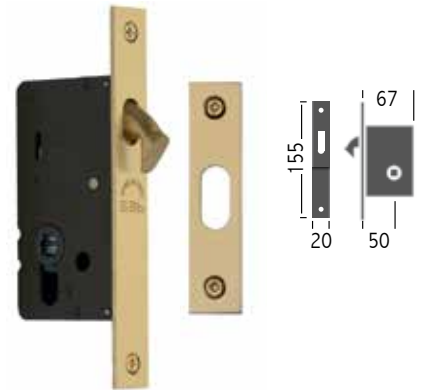

**SB** Satin Brass

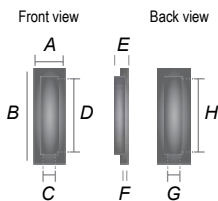

**C1872**  
Rectangular Flush Pull  
Matches the C1877 Flush Pull Privacy set shown above

Note:  
The recess measurement required to fit this item is taken from the back  
Sold and supplied in singles

| ITEM  | A  | B   | C  | D   | E  | F | G  | H   |
|-------|----|-----|----|-----|----|---|----|-----|
| C1872 | 57 | 197 | 40 | 161 | 10 | 2 | 50 | 172 |



FLUSH PULLS

All measurements are in mm

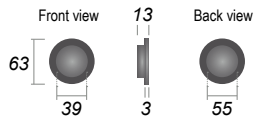

**C1835**  
Round Flush Pull

Note:  
The recess measurement required to fit this item is taken from the back  
Sold and supplied in singles

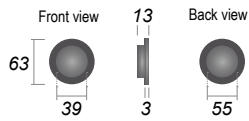
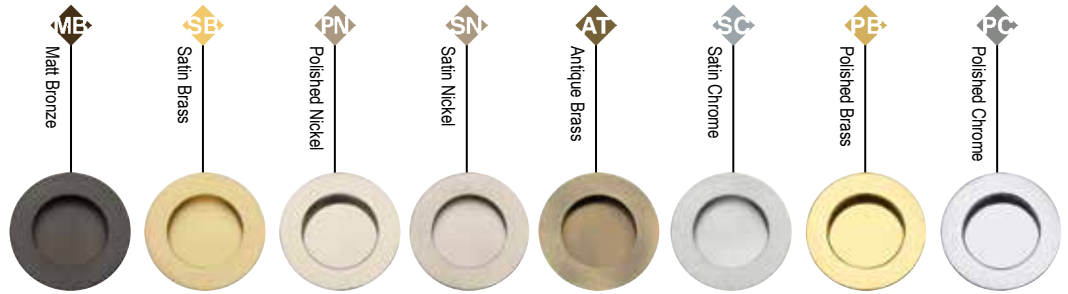

**C1837** [Design Reg: 6202497]  
Round Reeded Flush Pull

Note:  
The recess measurement required to fit this item is taken from the back  
Sold and supplied in singles

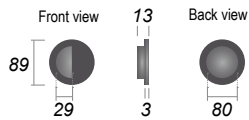

**C1845**  
Round Half Moon Flush Pull

Note:  
The recess measurement required to fit this item is taken from the back  
Sold and supplied in singles

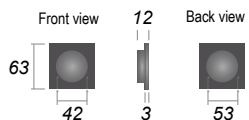

**C1860**  
Square Flush Pull

Note:  
The recess measurement required to fit this item is taken from the back  
Sold and supplied in singles



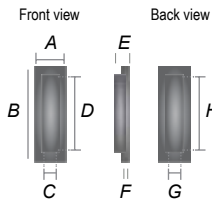

**C1855**

**Rectangular Flush Pull**

Note:  
The recess measurement required to fit this item is taken from the back  
Sold and supplied in singles

| ITEM      | A  | B   | C  | D   | E  | F | G  | H   |
|-----------|----|-----|----|-----|----|---|----|-----|
| C1855 105 | 58 | 105 | 30 | 75  | 13 | 2 | 44 | 85  |
| C1855 175 | 58 | 175 | 30 | 145 | 13 | 2 | 44 | 155 |
| C1855 300 | 58 | 300 | 30 | 270 | 13 | 2 | 44 | 280 |

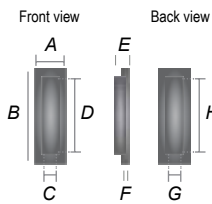
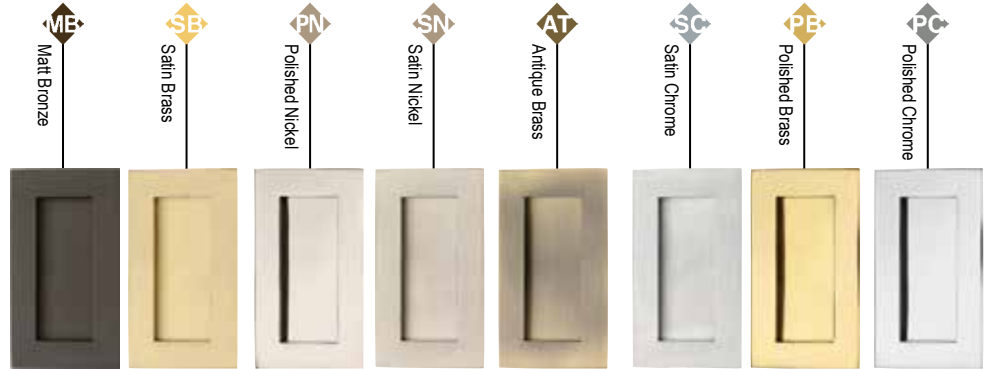

**C1865 [Design Reg: 6202496]**

**Reeded Rectangular Flush**

Note:  
The recess measurement required to fit this item is taken from the back  
Sold and supplied in singles

| ITEM      | A  | B   | C  | D   | E  | F | G  | H   |
|-----------|----|-----|----|-----|----|---|----|-----|
| C1865 105 | 58 | 105 | 30 | 75  | 13 | 2 | 44 | 85  |
| C1865 175 | 58 | 175 | 30 | 145 | 13 | 2 | 44 | 155 |
| C1865 300 | 58 | 300 | 30 | 270 | 13 | 2 | 44 | 280 |

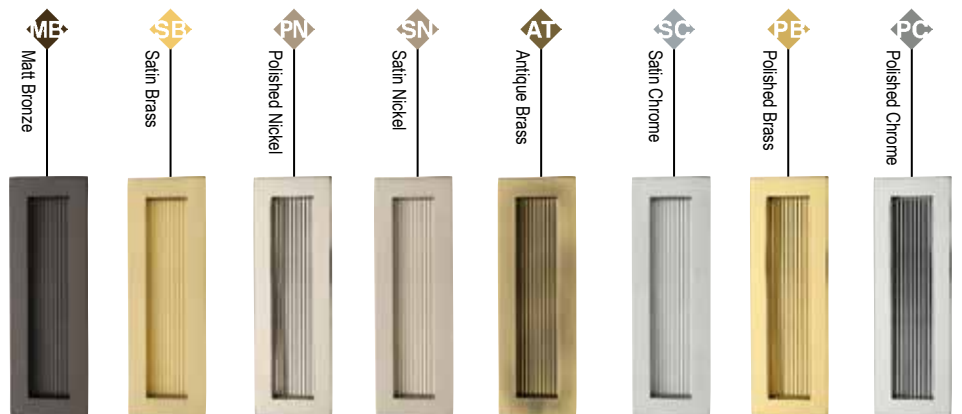

FLUSH PULLS

All measurements are in mm

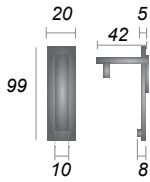

**C1165**  
Pocket Door Edge Pull

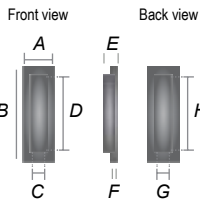

**C1820**  
Flush Pull Handle

Note:  
The recess measurement required to fit this item is taken from the back  
Sold and supplied in singles

| ITEM    | A  | B   | C  | D   | E  | F | G  | H   |
|---------|----|-----|----|-----|----|---|----|-----|
| C1820 4 | 52 | 101 | 21 | 54  | 15 | 3 | 27 | 71  |
| C1820 6 | 52 | 152 | 21 | 106 | 16 | 3 | 27 | 123 |

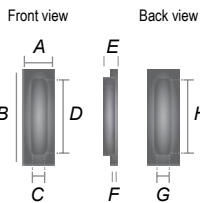

**C1850 105**  
Flush Pull Handle

Note:  
The recess measurement required to fit this item is taken from the back  
Sold and supplied in singles

| ITEM      | A  | B   | C  | D  | E  | F | G  | H   |
|-----------|----|-----|----|----|----|---|----|-----|
| C1850 105 | 44 | 105 | 30 | 77 | 12 | 3 | 37 | 100 |

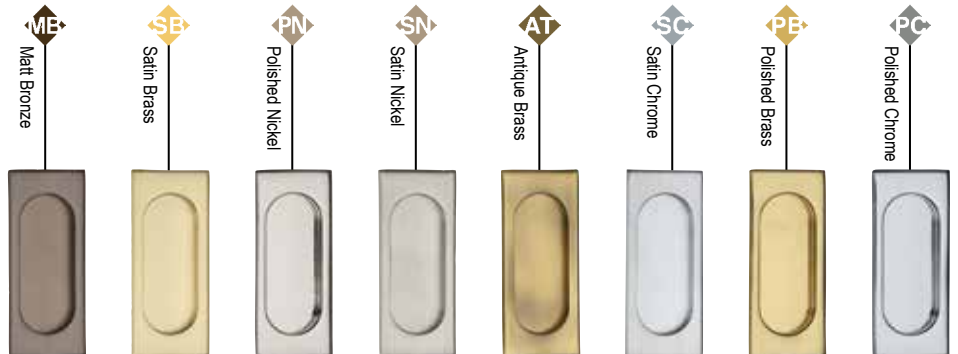



m.marcus  
architectural hardware

**M.Marcus Ltd.** Unit 7, Narrowboat Way, Dudley. DY2 0XQ  
Admin Tel: +44 1384 457900

Hardware Sales Tel: +44 1384 247844 Hardware Sales Fax: +44 1384 242252  
Hardware Sales e-mail: sales@m-marcus.com

Electrical Sales Tel: +44 1384 247845 - Electrical Sales Fax: +44 1384 243312  
Electrical Sales e-mail: electsales@m-marcus.com

Iseo Security Sales Tel: +44 1384 247833 - Iseo Sales Fax: +44 1384 253687  
Iseo Sales e-mail: iseosales@m-marcus.com

Our Website: <https://www.m-marcus.com>

Follow us: @heritagebrass

