



m. marcus  
architectural hardware



**Heritage Brass**  
SOLID BRASS DOOR FURNITURE



## *Matt Bronze Finish*

An aged finish on brass creating a vintage appearance, yet one that also looks outstanding in contemporary schemes. Over a period of time the bronze colour will lighten along any edges and surfaces that are frequently touched and create a naturally aged appearance highlighting frequently touched areas and exposing the brass below.



## *Antique Brass Finish*

With russet hues and a brass undertone this variation on brass retains a warm and mellow character but adds age and maturity by highlighting the variance of shades making each piece both alluring and unique.



## *Satin Nickel Finish*

With its honeyed grey tone created by brushed nickel plating on brass, this finish closely matches Stainless Steel but offers a warm and subtle alternative which is popular in traditional and modern décors.



## *Polished Nickel Finish*

With its subtle golden hue this is a mellow alternative to polished chrome. The finish is not coated and will oxidise naturally. If not regularly buffed with a soft cloth this finish will subtly change over time by taking on an aged patina.



## *Polished Brass Finish*

Warm, mellow with a sense of heritage and comfort this highly polished finish is opulent without being flamboyant. Polished Brass coordinates perfectly with traditional décor.



## *Satin Brass Finish*

A modern alternative finish to traditional polished brass this attractive brushed texture beautifully mellows the colour of solid brass and adds warmth to both a traditional and a soft contemporary décor.



## *Polished Chrome Finish*

A bold classic contemporary finish on Solid Brass. The mirror effect reflects light and colours of the surroundings and will complement perfectly any fashionable colour scheming. Polished Chrome is easy to clean and is low maintenance.





## *Satin Chrome Finish*

The brush marks of satin chrome will appeal to those who favour an industrial yet contemporary chrome finish.  
Satin Chrome Finish is also less prone to finger marks than polished chrome.



## *Combination Finishes*

Apollo [AP] combines Polished Chrome and Satin Chrome  
Jupiter [JP] combines Gold Plate with Satin Nickel  
Mayfair [MF] combines Polished Brass with Satin Brass  
Mercury [MC] combines Polished Nickel with Satin Nickel  
Chrome/Brass Finish [CB] combines Polished Chrome with Polished Brass

These blends of two finishes will appeal to those who like contrast and distinction.

LEVERS ON PLATE . . . . .11-25

Adam	25	Kendal	14
Algarve	24	Lisboa	17
Ambassador	15	Luna	23
Astoria	11	Maya	24
Atlantis	12	Meridian	20
Bauhaus	13	Metro	13
Bedford	19	Sandown	18
Buckingham	20	Saturn	16
Centaur	15	Savoy	20
Charlbury	18	Savoy Long	25
Deco	14	Sophia	21
Delta	14	Sutton	23
Diplomat	15	Tiffany	11
Edwardian	19	Trident	13
Gainsborough	25	Verona	17
Georgian	25	Victoria	22
Gloucester	23	Vienna	16
Henley	16	Waldorf	12
Hilton	21	Windsor	22
Howard	18		

LEVERS ON ROSE . . . . .26-37

Algarve	29	Ellipse	27
Alicia	28	Gio	31
Amazon	36	Harmony	30
Bauhaus	31	Linear	35
Bauhaus SQ	36	Lisboa	34
Bauhaus - LP	37	Pyramid	27
Bedford	29	Roma	33
Bellagio	31	Sophia	33
Celia	30	Sutton	30
Centaur	27	Trident	27
Century	32	Trident - LP	37
Challenger	28	Tiffany	32
Charlbury	33	Turin	28
Colonial	35	Vela (not illustrated)	
Columbus	30	Vienna	28
Crystal	34	Volo	29
Delta - LP	37	Wing	29
Delta SQ	36		

MORTICE KNOBS . . . . .38-46

Aydon	42	Richmond	41
Aylesbury	41	Reeded	40
Chelsea	43	Suffolk	40
Goodrich	41	Victoria	40
Hampstead	43	Westminster	39
Kensington	39	Whitehall	43
Mayfair	39	Porcelain Range	45, 46

MORTICE KNOB ON PLATE . . . 44

Balmoral	44	Charlston	44
Broadway	44		

EXTERNAL DOOR HARDWARE . . . . .47-51

Letter Plates / 47, 48

Knockers and Centre Door Knobs / 49, 50

Alphabet and Numerals / 50, 51

BRASS HINGES . . . . . 52

BOLTS . . . . . 53

WINDOW FITTINGS . . . . . 54

HOOKS & DOOR STOPS . . . 55

PULL HANDLES . . . . .56-62

Large Pulls / 57 - 61

Flush Pulls / 62

CABINET HARDWARE . . . 63-71

Cabinet Knobs / 64 - 66	Cabinet Drops / 67
Drawer Pulls / 68	Cabinet Pulls / 69 - 71

SOLID BRONZE RUSTIC .72-81

BLACK IRON RUSTIC . . .82-91

PERIOD BLACK IRON TUDOR COLLECTION . . .92-99

ELECTRICAL ACCESSORIES 100-102

Studio Concealed Fixing - (Many more ranges are available)

LOCKS & LATCHES . . . 103-107

Finishes & Product Care . . . . . 108

Frequently Asked Questions & Warranties . . . . . 109

# Astoria

- AST5900** Lever Lock
- AST5910** Lever Latch
- AST5930** Bathroom Set
- AST5948** Euro Profile

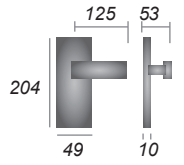

**Charleston**  
Page - 44



**Broadway**  
Page - 44



**Tiffany on Rose**  
Page - 32

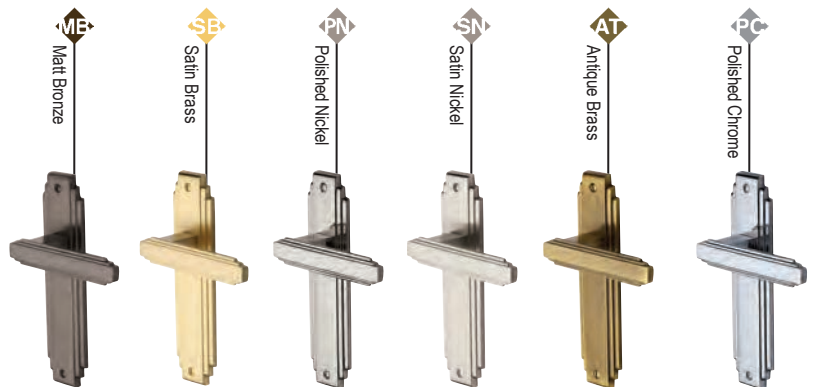

# Tiffany

- TIF5200** Lever Lock
- TIF5210** Lever Latch
- TIF5230** Bathroom Set
- TIF5248** Euro Profile

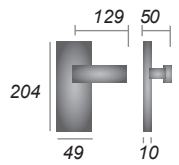

# Atlantis

- ATL5700** Lever Lock
- ATL5710** Lever Latch
- ATL5730** Bathroom Set
- ATL5748** Euro Profile

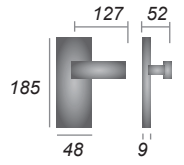

Linear  
Page - 35



# Waldorf

- WAL6500** Lever Lock
- WAL6510** Lever Latch
- WAL6530** Bathroom Set
- WAL6548** Euro Profile

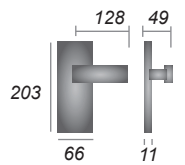

## Trident Low Profile



- TRI1300** Lever Lock
- TRI1310** Lever Latch
- TRI1330** Bathroom Set
- TRI1348** Euro Profile

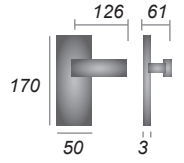

## Metro Low Profile



- MET4900** Lever Lock
- MET4910** Lever Latch
- MET4930** Bathroom Set
- MET4948** Euro Profile

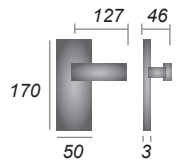

## Bauhaus Low Profile



- BAU7300** Lever Lock
- BAU7310** Lever Latch
- BAU7330** Bathroom Set
- BAU7348** Euro Profile

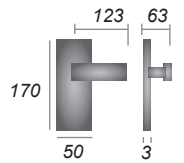

- Low profile plates are only suitable for minimum 44mm door thickness
- A 38mm bore will be required to accept spring mechanism

## Delta



- DEL6000** Lever Lock
- DEL6010** Lever Latch
- DEL6030** Bathroom Set
- DEL6048** Euro Profile

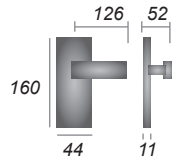

## Kendal



- KEN6800** Lever Lock
- KEN6810** Lever Latch
- KEN6830** Bathroom Set
- KEN6848** Euro Profile

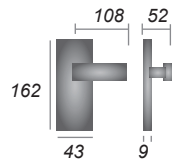

## Deco



- DEC3000** Lever Lock
- DEC3010** Lever Latch
- DEC3030** Bathroom Set
- DEC3048** Euro Profile

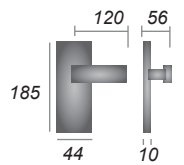

## Ambassador



- AMB6200** Lever Lock
- AMB6210** Lever Latch
- AMB6230** Bathroom Set
- AMB6248** Euro Profile

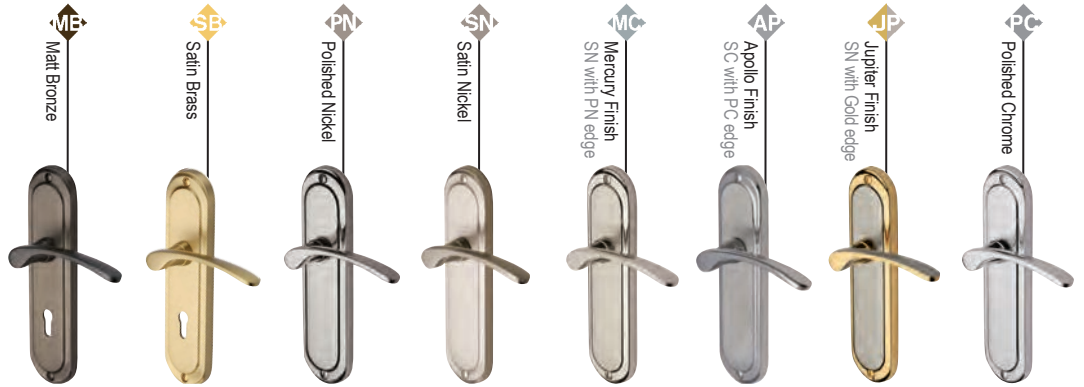
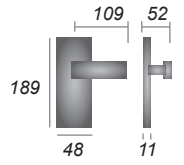

## Diplomat



- DIP7800** Lever Lock
- DIP7810** Lever Latch
- DIP7830** Bathroom Set
- DIP7848** Euro Profile

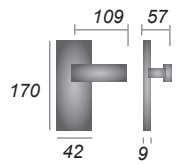

## Centaur



- CEN1000** Lever Lock
- CEN1010** Lever Latch
- CEN1030** Bathroom Set
- CEN1048** Euro Profile

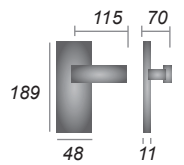



# Henley



- HEN1200** Lever Lock
- HEN1210** Lever Latch
- HEN1230** Bathroom Set
- HEN1248** Euro Profile

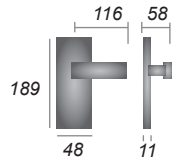

# Saturn



- SAT1000** Lever Lock
- SAT1010** Lever Latch
- SAT1030** Bathroom Set
- SAT1048** Euro Profile

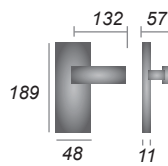

# Saturn Long

- SAT2000** Lever Lock
- SAT2010** Lever Latch
- SAT2030** Bathroom Set
- SAT2048** Euro Profile

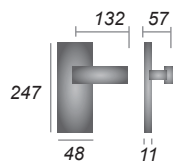

# Vienna



- VIE3300** Lever Lock
- VIE3310** Lever Latch
- VIE3330** Bathroom Set
- VIE3348** Euro Profile

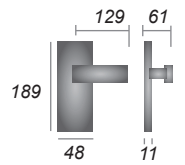

## Verona



- MM624** Lever Lock
- MM627** Lever Latch
- MM628** Bathroom Set
- MM625** Euro Profile

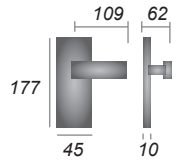

## Verona Long



- MM824** Lever Lock
- MM827** Lever Latch
- MM828** Bathroom Set
- MM825** Euro Profile

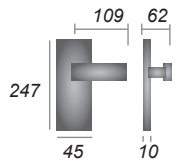

## Lisboa



- MM991** Lever Lock
- MM992** Lever Latch
- MM993** Bathroom Set
- MM994** Euro Profile

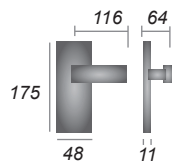

## Charlbury



- V7050** Lever Lock
- V7060** Lever Latch
- V7070** Bathroom Set
- V7066** Euro Profile

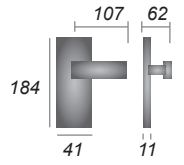

## Howard



- HOW1300** Lever Lock
- HOW1310** Lever Latch
- HOW1330** Bathroom Set
- HOW1348** Euro Profile

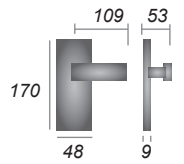

## Sandown



- SAN1400** Lever Lock
- SAN1410** Lever Latch
- SAN1430** Bathroom Set
- SAN1448** Euro Profile

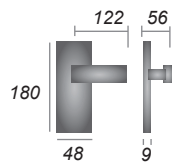

## Edwardian



- W3200** Lever Lock
- W3213** Lever Latch
- W3220** Bathroom Set
- W3227** Euro Profile

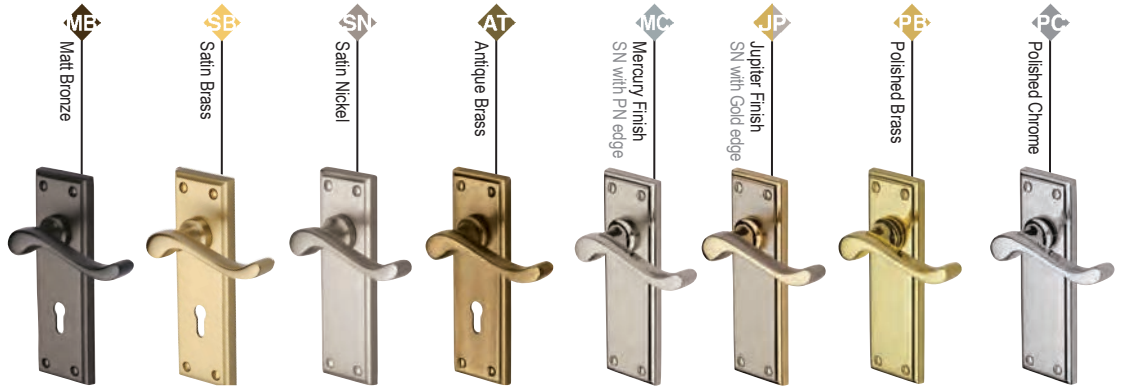
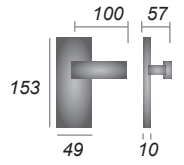

## Bedford



- V810** Lever Lock
- V803** Lever Latch
- V815** Bathroom Set
- V807** Euro Profile
- V805** Oval Profile

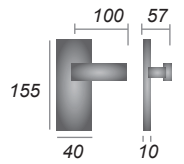

## Bedford Short



- V800** Lever Latch
- V825** Privacy Set

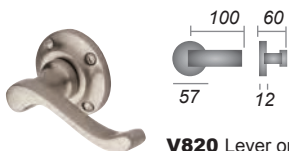
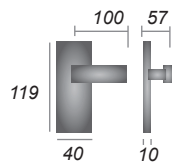

**V820** Lever on Rose  
in all finishes shown



## Meridian

- V300** Lever Lock
- V313** Lever Latch
- V330** Bathroom Set
- V327** Euro Profile

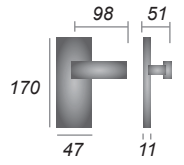

## Buckingham

- W4200** Lever Lock
- W4210** Lever Latch
- W4220** Bathroom Set
- W4248** Euro Profile

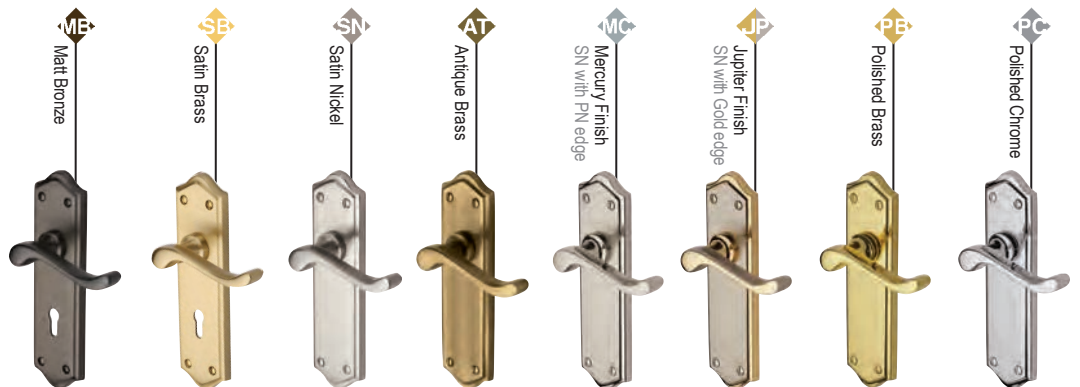
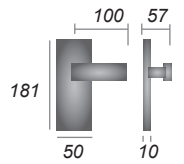

## Savoy

- S600** Lever Lock
- S610** Lever Latch
- S620** Bathroom Set
- S607** Euro Profile

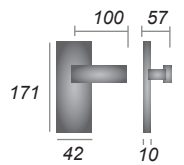

## Sophia



- V4130** Lever Lock
- V4113** Lever Latch
- V4142** Bathroom Set
- V4146** Euro Profile

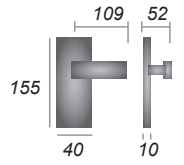

## Sophia Short



- V4140** Lever Latch
- V4144** Privacy Set

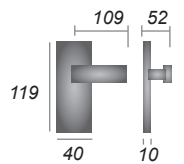

## Hilton



- HIL8600** Lever Lock
- HIL8610** Lever Latch
- HIL8630** Bathroom Set
- HIL8648** Euro Profile

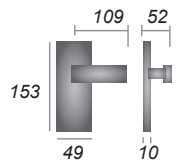

## Windsor



- V700** Lever Lock
- V713** Lever Latch
- V730** Bathroom Set
- V727** Euro Profile
- V725** Oval Profile

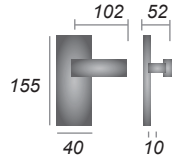

## Windsor Short



- V710** Lever Latch
- V735** Privacy Set

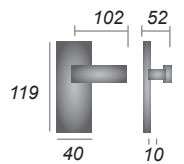

**V720** Lever on Rose  
*in all finishes shown*

## Victoria



- V3900** Lever Lock
- V3910** Lever Latch (119 x 40)
- V3913** Lever Latch (154 x 40)
- V3930** Bathroom Set
- V3935** Privacy Set (119 x 40)
- V3948** Euro Profile

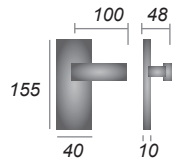

- V3910** Lever Latch
- V3935** Privacy Set

## Gloucester



- V6050** Lever Lock
- V6060** Lever Latch
- V6070** Bathroom Set
- V6066** Euro Profile

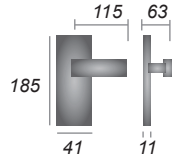

## Luna



- LUN5300** Lever Lock
- LUN5310** Lever Latch
- LUN5330** Bathroom Set
- LUN5348** Euro Profile

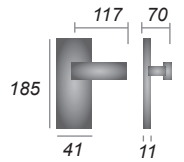

## Sutton



- V6052** Lever Lock
- V6054** Lever Latch
- V6058** Bathroom Set
- V6057** Euro Profile

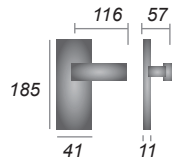



# Maya



- MAY7600** Lever Lock
- MAY7610** Lever Latch
- MAY7630** Bathroom Set
- MAY7648** Euro Profile

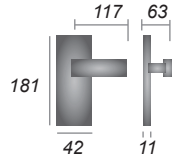

# Algarve



- MM924** Lever Lock
- MM927** Lever Latch
- MM928** Bathroom Set
- MM925** Euro Profile

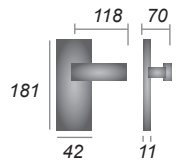

# Algarve Long



- MM7200** Lever Lock
- MM7210** Lever Latch
- MM7230** Bathroom Set
- MM7248** Euro Profile

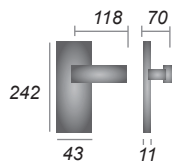

## Savoy Long



- V750** Lever Lock
- V760** Lever Latch
- V765** Bathroom Set
- V757** Euro Profile

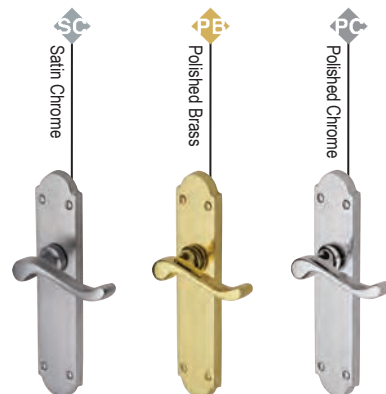
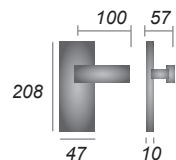

## Adam



- R750** Lever Lock
- R760** Lever Latch
- R765** Bathroom Set
- R768** Euro Profile

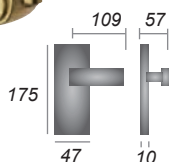

- G010** Lever Lock
- G020** Lever Latch
- G025** Bathroom Set
- G028** Euro Profile

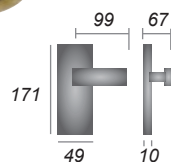

## Gainsborough

## Georgian



- G040** Lever Lock
- G063** Lever Latch
- G050** Bathroom Set
- G046** Euro Profile

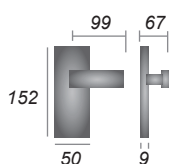

## Georgian Short



- G060** Lever Latch
- G055** Privacy Set

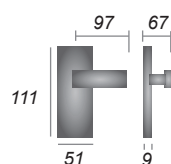



*Lever on Rose*

# Centaur

**V3490**

• Also available in Satin Chrome (SC)

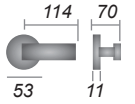

# Pyramid

**PYD3535**

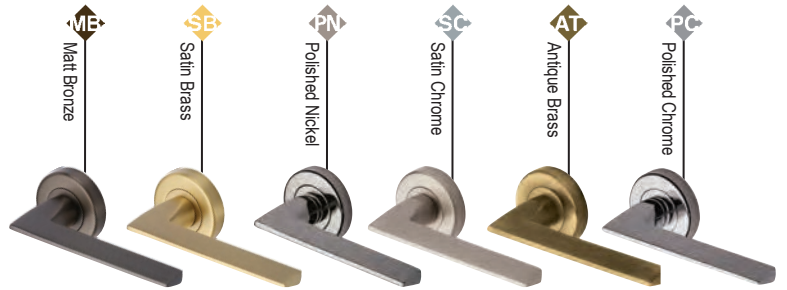
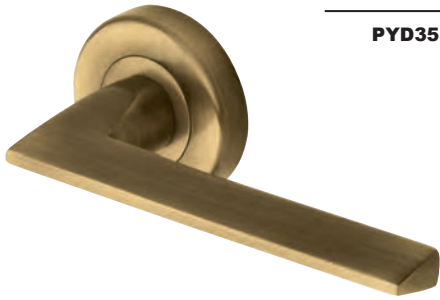
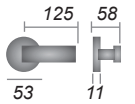

# Ellipse

**ELL4242**

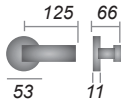

# Trident

**TRI1352**

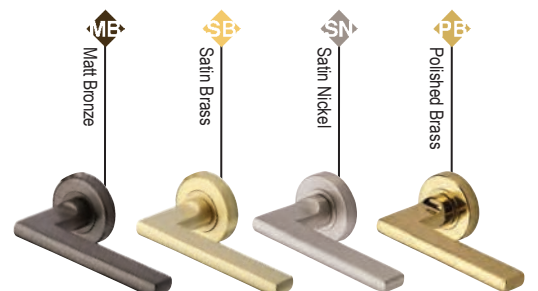
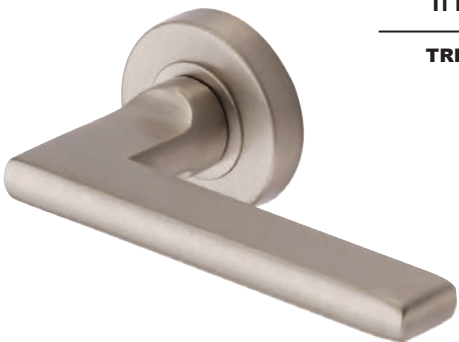
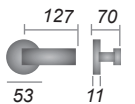

## Turin

V1850

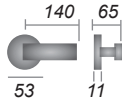
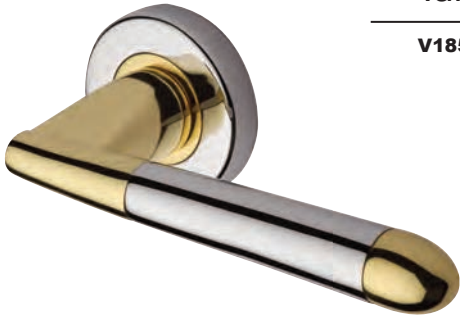

## Vienna

VIE1920

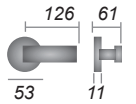

## Challenger

V1001

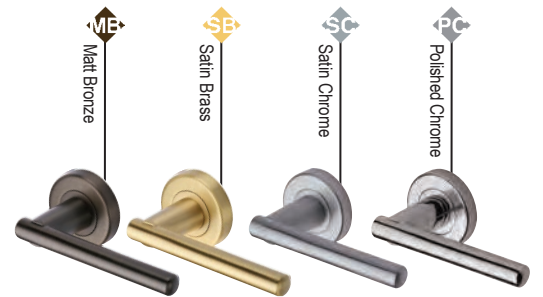
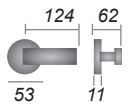

## Alicia

V2100

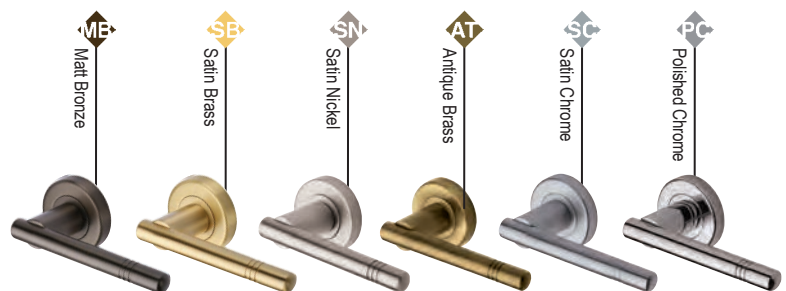
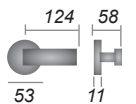

## Volo

V1950

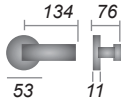

## Algarve

V7210

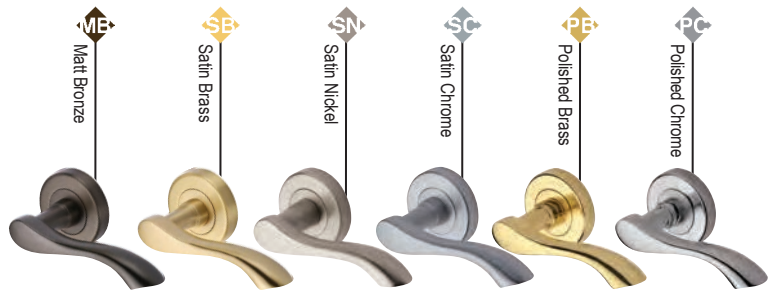
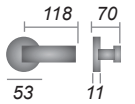

## Wing

V1121

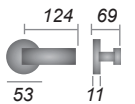

## Bedford

V3010

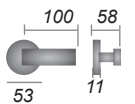

## Columbus

COL1762

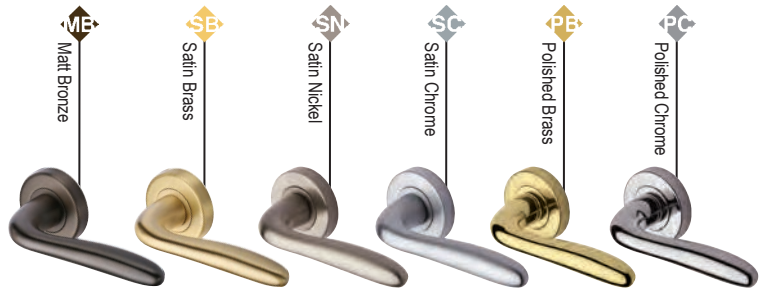
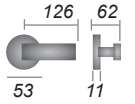

## Sutton

V1750

Also available in Polished Nickel finish (PN)

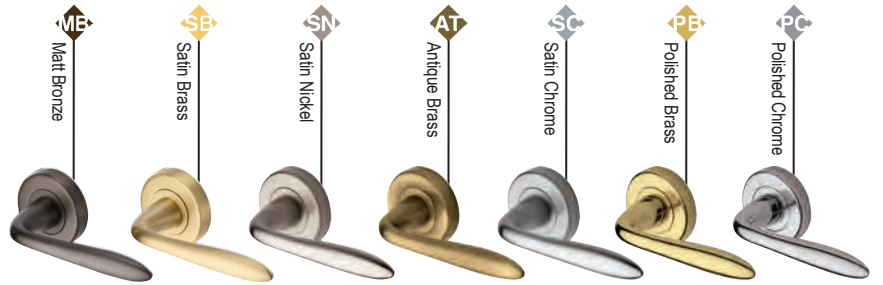
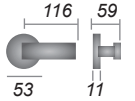

## Harmony

V3090

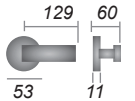

## Celia

V7450

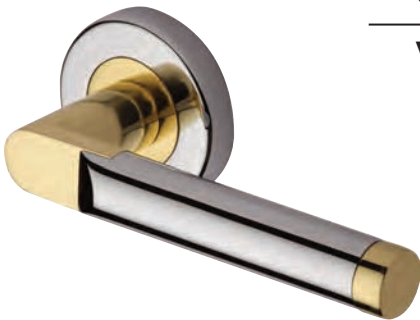
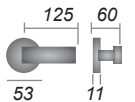

# Gio

V4189

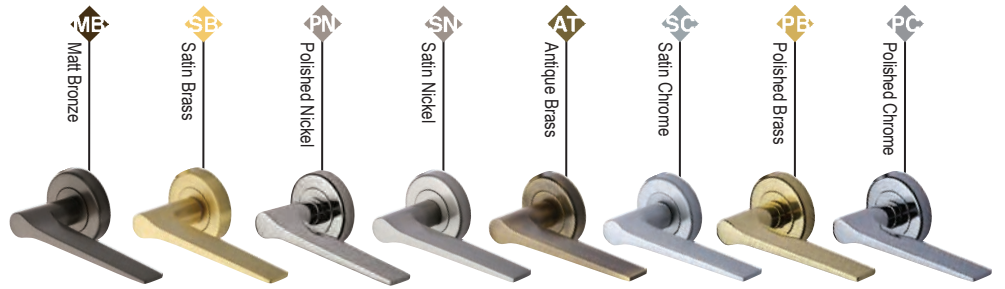
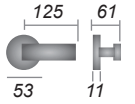

# Bellagio

V2015

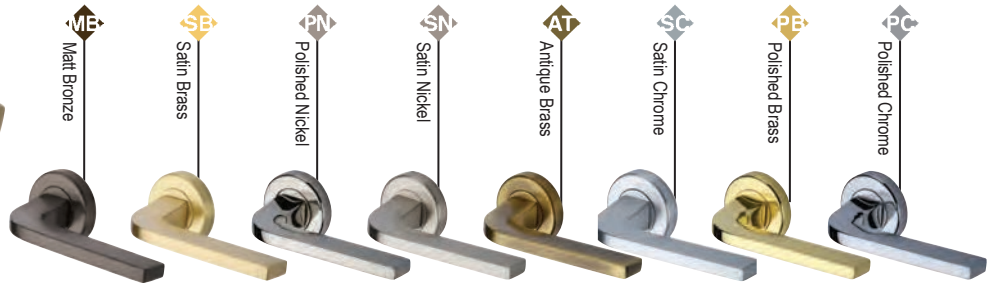
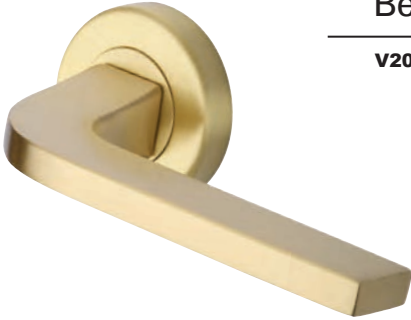
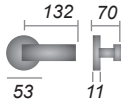

# Bauhaus

V2259

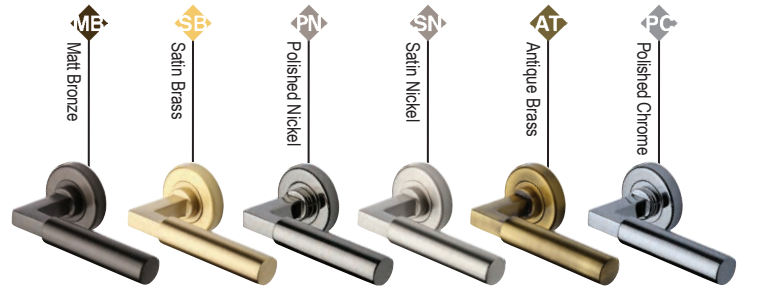
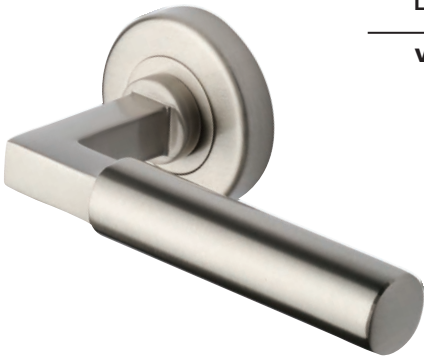
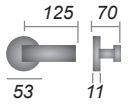

Diameter 53mm



**V4035**  
Turn & Release



**V0678**  
Turn & Release



**V4000**  
Key Escutcheon



**V4010**  
Oval Profile



**V4020**  
Euro Profile

Diameter 46mm



**V4049** Turn & Release



**V4007**  
Key Escutcheon



**V4009**  
Oval Profile



**V4008**  
Euro Profile



# Century

**CEN1924**

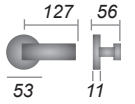

# Tiffany

**TIF1926**

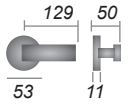

Diameter 53mm

Accessories to match Century & Tiffany



**ERD7030**  
Turn & Release



**ERD7000**  
Key Escutcheon



**ERD7020**  
Euro Profile



**V4043**  
Contemporary Turn & Release

ME SB CE AP SN AT SC PE PC MC PN



**V4046**  
Indicator Turn & Release

SC PE PC ME AT



**V4044**  
Turn & Release

SC PE PC ME AT



**V4048**  
Indicator Turn & Release

SC PE PC ME AT

Diameter 35mm

ME SB PN SN AT SC PE PC



**V1018** Turn & Release

# Roma

V7155

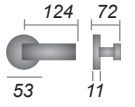

# Charlbury

V3020

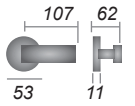

# Sophia

V1900

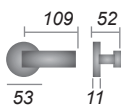

# Crystal



**V2003**  
SWAROVSKI crystal lever

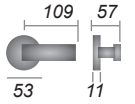

# Lisboa



**V1601**

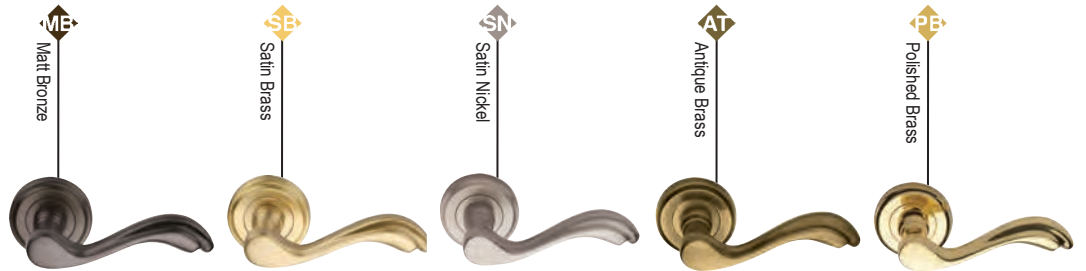
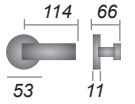

Diameter 50mm



**V4045**  
Turn & Release



**V5000**  
Key Escutcheon



**V5010**  
Oval Profile



**V5020**  
Euro Profile



**V4040**  
Turn & Release



# Colonial

V1932

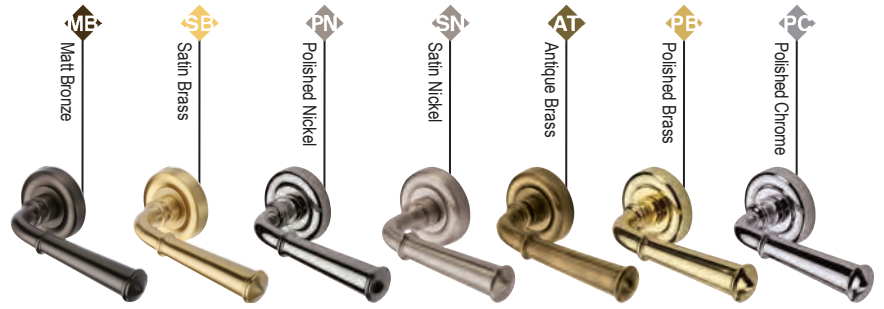
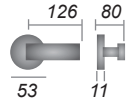

Diameter 53mm



**V6720**  
Turn & Release



**V6722**  
Key Escutcheon



**V6724**  
Euro Profile

# Linear

DEC5430

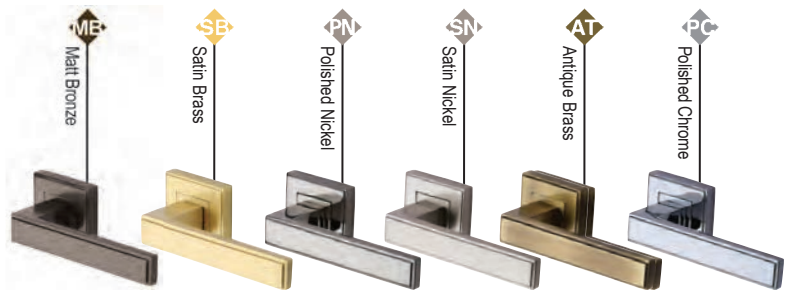
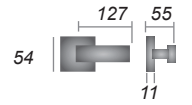

Size 54 x 54mm



**DEC7030**  
Turn & Release



**DEC7000**  
Key Escutcheon



**DEC7020**  
Euro Profile

## Bauhaus SQ



**SQ1926**

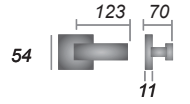

## Amazon

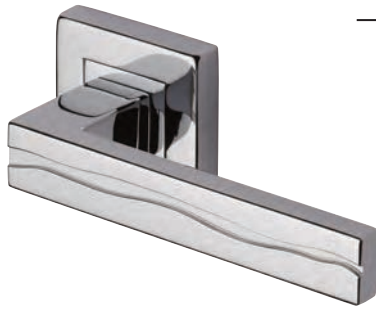

**SQ5440**

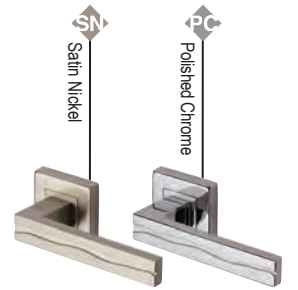
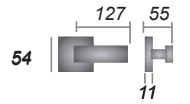

## Delta SQ



**SQ5420**

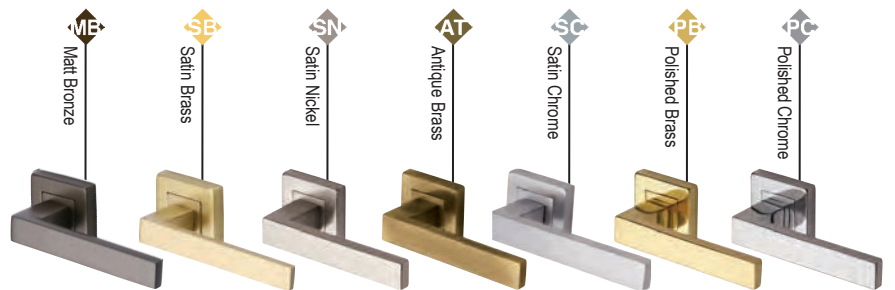
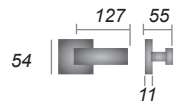

Size 54 x 54mm



**SQ4043**  
Turn & Release



**SQ4035**  
Turn & Release



**SQ5002**  
Key Escutcheon



**SQ5004**  
Euro Profile

## Bauhaus Low Profile

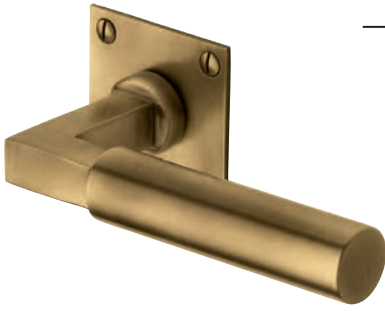

**BAU1926** Exposed fixings

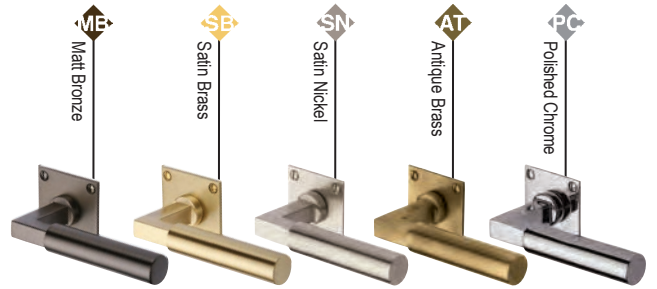
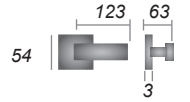

## Delta Low Profile

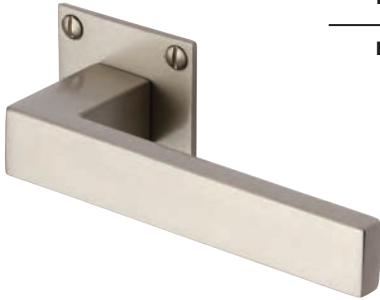

**BAU1928** Exposed fixings

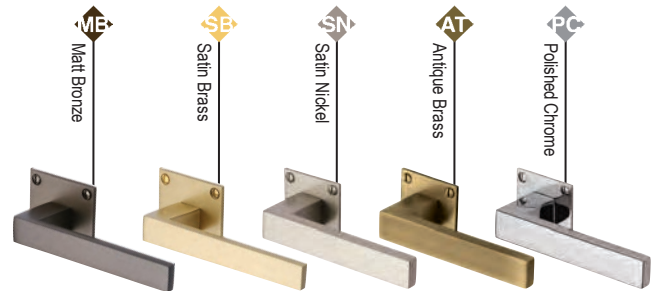
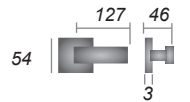

## Trident Low Profile

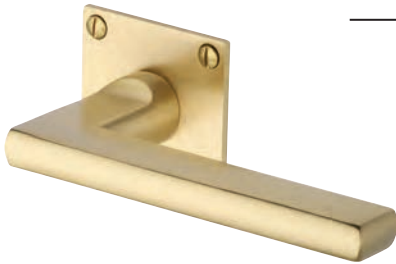

**BAU2910** Exposed fixings

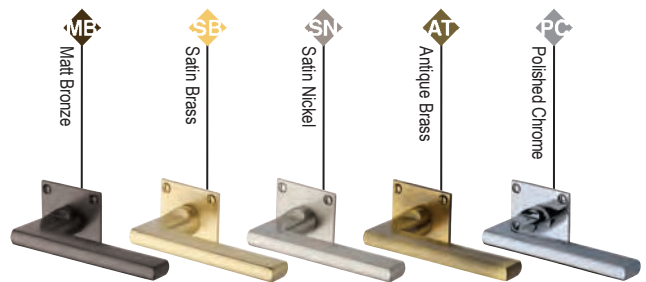
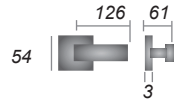

*Please note:*

- Low profile plates are only suitable for minimum 44mm door thickness
- A 38mm bore will be required to accept spring mechanism

Size 54 x 54mm



**BAU1555** Turn & Release



**BAU1556** Keyhole Escutcheon



**BAU1558** Euro Profile



## *Mortice Knobs*

- All mortice knobs are sprung one side only unless otherwise stated

# Westminster

**WES970**

64 |  79



• All Mortice Knobs shown on this page are unsprung and will need to be installed with a 3" heavy duty latch.



# Mayfair

**MAY960**

64 |  76

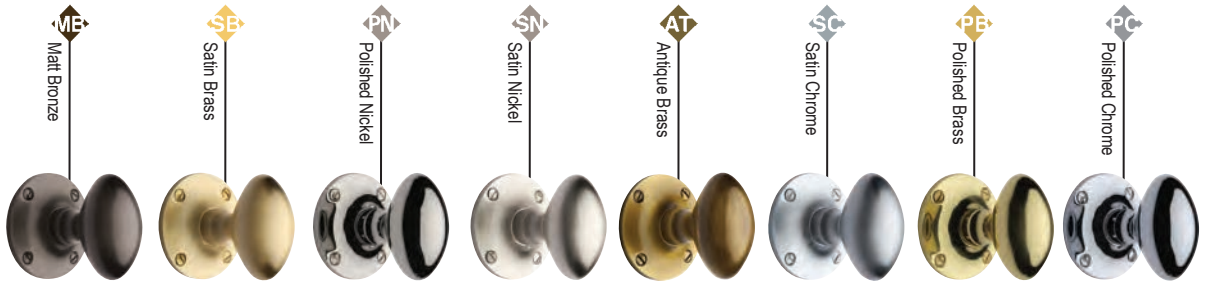
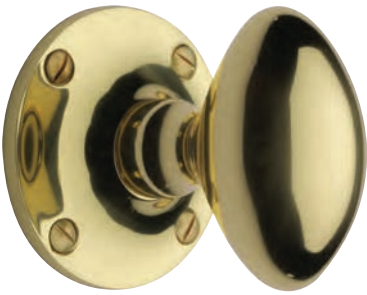

# Kensington

**KEN980**

64 |  66







## Suffolk

**V960**

**RIM-V960**  
Rim Knob



• All mortice knobs on this page are sprung one side only and will need to be installed with a lightly sprung or standard 3" Tubular Latch

• All RIM knob sets used with RIM Locks are unsprung. See inset image and separate product code

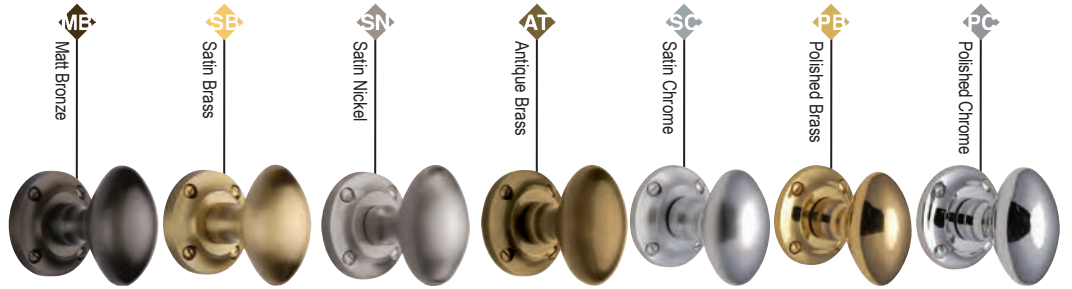

## Victoria

**V980**

**RIM-V980**  
Rim Knob



## Reeded

**V971**

**RIM-V971**  
Rim Knob



## Goodrich

**GOO986**



• All Mortice Knobs shown on this page are sprung on one side and will need to be installed with a lightly sprung or standard 3" Tubular Latch



## Richmond

**RHM988**

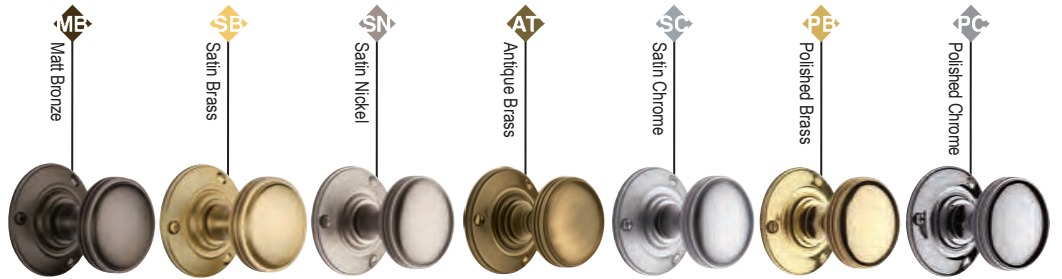

## Aylesbury

**V872**

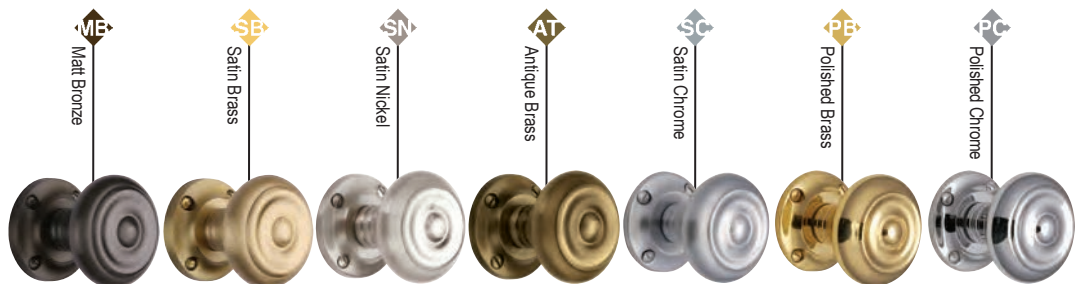



• All Mortice Knobs shown on this page are sprung on one side and will need to be installed with a lightly sprung or standard 3" Tubular Latch



All items all finishes unless otherwise indicated ~~ME~~ ~~SB~~ ~~PN~~ ~~SN~~ ~~AT~~ ~~SC~~ ~~PB~~ ~~PC~~



**S640**  
Shaped Fingerplate  
305 x 77mm



**V743**  
Fingerplate  
282 x 63mm



**V740** Fingerplate  
**V740 305** 305 x 76mm  
**V740 500** 500 x 76mm



**V1022**  
Covered Oval Escutcheon  
59 x 20mm  
Projection 15mm



**V1010**  
Round Open Escutcheon  
Diameter 32mm



**V1020**  
Round Covered Escutcheon  
Diameter 33mm

**BT15**  
Thumbturn & Release  
Diameter 36mm



**V1015**  
Thumbturn & Release  
Diameter 45mm



**V1012** ~~SC~~ ~~PB~~ ~~PC~~ ~~SN~~ ~~AT~~  
Euro Profile Escutcheon  
Diameter 45mm



**V1013** ~~SC~~ ~~PB~~ ~~PC~~ ~~SN~~ ~~AT~~  
Oval Profile Escutcheon  
Diameter 45mm



**V1014** ~~SC~~ ~~PB~~ ~~PC~~ ~~SN~~ ~~AT~~  
Round Open Escutcheon  
Diameter 45mm



**V972**  
Reeded Covered Escutcheon  
Diameter 33mm

## Whitehall CONCEALED FIXING

**WHI6429**

63 | 70

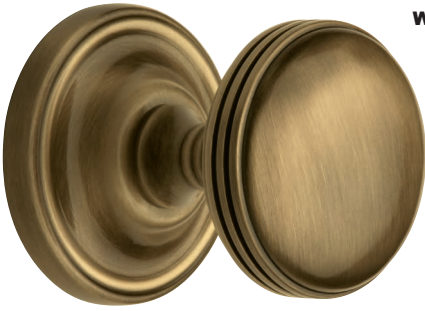

• All Mortice Knobs shown on this page are sprung on one side and will need to be installed with a lightly sprung or standard 3" Tubular Latch

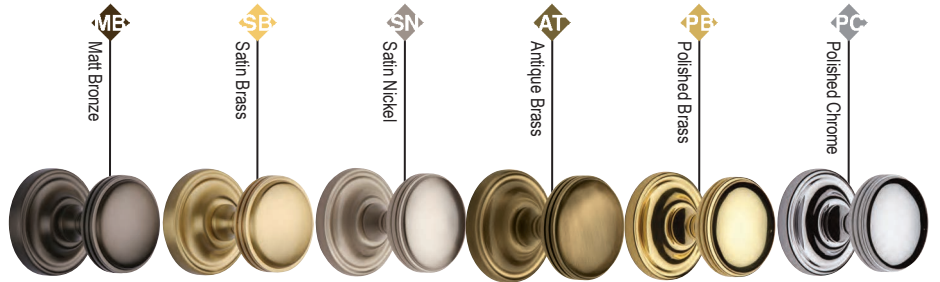

## Chelsea CONCEALED FIXING

**CHE7373**

63 | 80

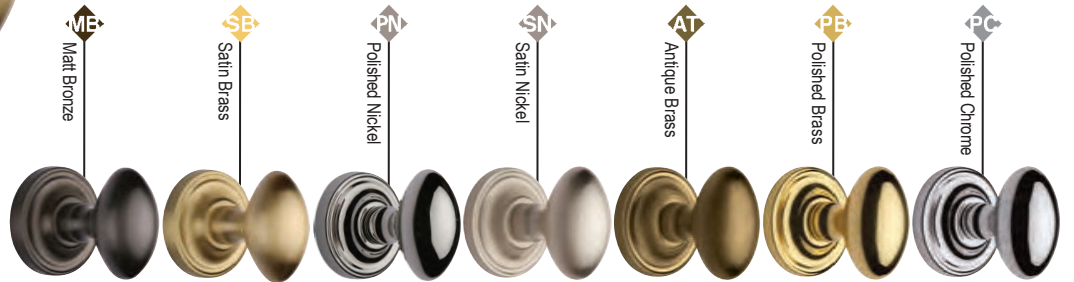

## Hampstead CONCEALED FIXING

**HAM8361**

63 | 72

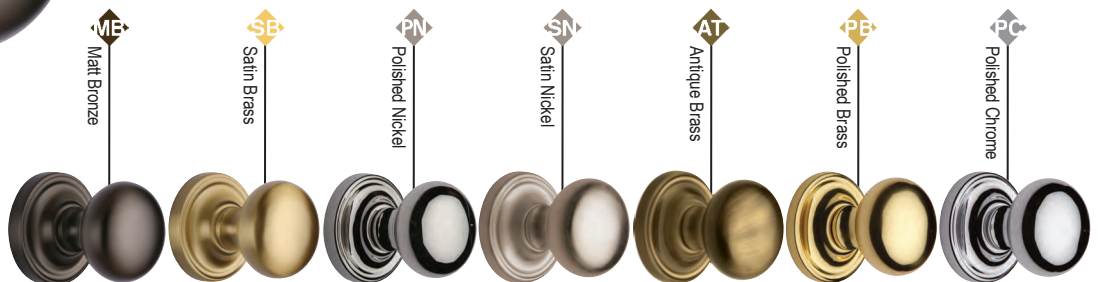

## Charlston

• All Mortice Knobs shown on this page are sprung on one side and will need to be installed with a lightly sprung or standard 3" Tubular Latch



- CHA1900** Lever Lock
- CHA1910** Lever Latch
- CHA1930** Bathroom Set
- CHA1948** Euro Profile

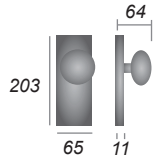

## Broadway



- BR1800** Lever Lock
- BR1810** Lever Latch
- BR1830** Bathroom Set
- BR1848** Euro Profile

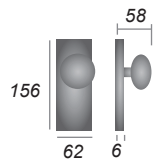

## Balmoral



- BAL8500** Lever Lock
- BAL8510** Lever Latch
- BAL8530** Bathroom Set
- BAL8548** Euro Profile

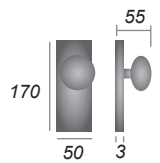

- Low profile plates are only suitable for minimum 44mm door thickness
- A 38mm bore will be required to accept spring mechanism

## Plain White Porcelain

5010

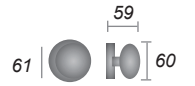

• All Mortise Knobs shown on this page are unsprung and will need to be installed with a 3" heavy duty latch.

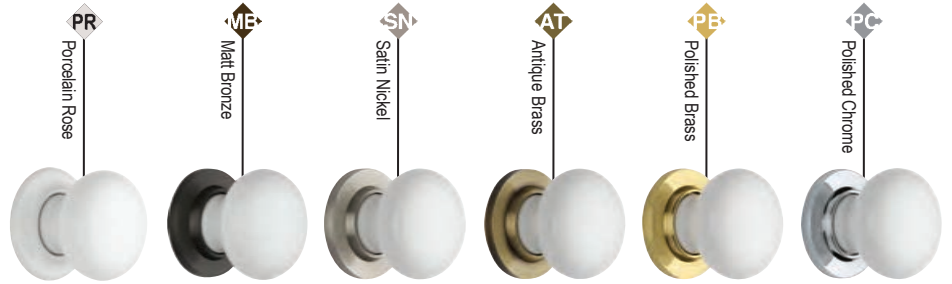

## Gold Line Porcelain

6010

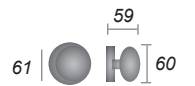

## White Crackle Porcelain

7010

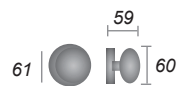

# Cream Crackle Porcelain

8010

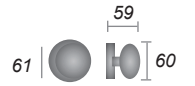

• All Mortise Knobs shown on this page are unsprung and will need to be installed with a 3" heavy duty latch.

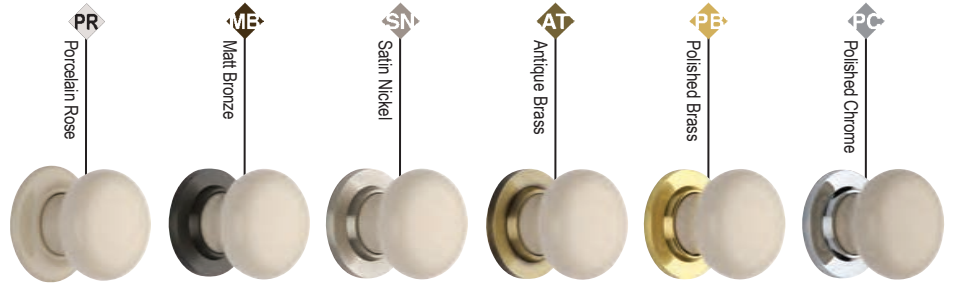

**V1022**  
Covered Oval Escutcheon  
59 x 20mm  
Projection 15mm



**5030** Plain White Covered Escutcheon  
63 x 21mm



**6030** Gold Line Covered Escutcheon  
63 x 21mm



**7030** White Crackle Covered Escutcheon  
63 x 21mm



**8030** Cream Crackle Covered Escutcheon  
63 x 21mm



**5000** Plain White Shaped Fingerplate  
280 x 77mm



**6000** Gold Line Shaped Fingerplate  
274 x 75mm



**7000** White Crackle Shaped Fingerplate  
280 x 77mm



**8000** Cream Crackle Shaped Fingerplate  
280 x 77mm



**5032** Plain White Cabinet Knob  
Top diameter 32mm

**5038** Plain White Cabinet Knob  
Top diameter 38mm



**6032** Gold Line Cabinet Knob  
Top diameter 32mm

**6038** Gold Line Cabinet Knob  
Top diameter 38mm



**7032** White Crackle Cabinet Knob  
Top diameter 32mm

**7038** White Crackle Cabinet Knob  
Top diameter 38mm



**8032** Cream Crackle Cabinet Knob  
Top diameter 32mm

**8038** Cream Crackle Cabinet Knob  
Top diameter 38mm

EXTERNAL DOOR HARDWARE - LETTER PLATES



**V850**  
Letter Plate

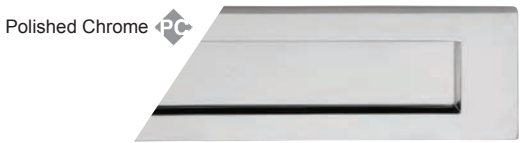
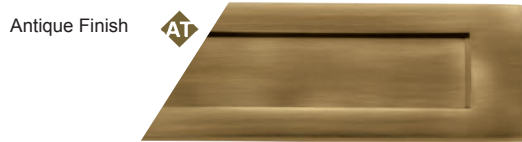

- V850 8"** 203 x 76mm  
Aperture 144 x 38mm  
C to C: 172mm
- V850 10"** 254 x 79mm  
Aperture 188 x 42mm  
C to C: 219mm
- V850 10.4"** 254 x 102mm  
Aperture 208 x 50mm  
C to C: 230mm
- V850 12"** 305 x 102mm  
Aperture 248 x 60mm  
C to C: 275mm
- V850 13"** 331 x 80mm  
Aperture 258 x 36mm  
C to C: 295mm
- V850 14"** 356 x 127mm  
Aperture 287 x 64mm  
C to C: 320mm
- V850 16"** 411 x 125mm  
Aperture 325 x 70mm  
C to C: 367mm



**V830 10"**  
Postal Kicker  
254 x 79mm  
Aperture 188 x 42mm  
C to C: 219mm



**V842 11"**  
Letter Plate Gravity Flap  
280 x 80mm  
Aperture 207 x 48mm  
C to C: 243mm





EXTERNAL DOOR HARDWARE - LETTER PLATES



**V843 11"**  
Gravity Letter Plate  
280 x 78mm  
Aperture: 215 x 42mm  
C to C: 250mm



**V845**  
Embossed Letter Plate  
254 x 101mm  
Aperture 172 x 46mm  
C to C: 220mm



**V860**  
Interior Letterflap  
**V860 280 (Small)**  
280 x 83mm  
For letter plates up to 10"  
**V860 299 (Large)**  
299 x 83mm  
For letter plates up to 12"



All below items all finishes ME SB PN SN AT SC PE PC



**V1070** Door Chain  
100mm



**V933** Cylinder Pull  
84 x 45mm



**V1180**  
Oblong Bell Push  
83 x 33mm



**V930** Cylinder Pull  
84 x 45mm

## EXTERNAL DOOR HARDWARE - DOOR KNOCKERS

All items all finishes 



**V910**  
Urn Knocker  
152 x 66mm  
195 x 100mm



**K1210**  
Lion Knocker  
177 x 107mm



**K1270**  
Ring Knocker  
Diameter  
inner 77mm  
outer 107mm

**K1310**  
Slim Knocker  
165 x 40mm



**K1300**  
Doctor Knocker  
192 x 43mm  
Base diameter 55mm



**K1320**  
Door Knocker  
68 x 159mm

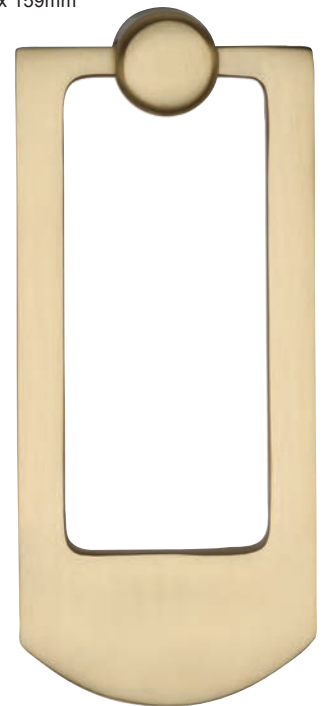



**V908**  
Square Centre Door Knob  
Base 89mm Knob 76mm Projection 72mm



**V901**  
Centre Door Knob  
Base 78mm Knob 68mm Projection 80mm



**V900**  
Centre Door Knob  
Base 79mm Knob 77mm Projection 80mm



**V890**  
Centre Door Knob  
Base 82mm Knob 71mm Projection 83mm



**V880**  
Faceted Centre Door Knob  
Base 66mm Knob 57mm Projection 81mm



**V905**  
Centre Door Knob  
Base 89mm Knob 76mm Projection 80mm



**C1565**  
Alphabet Pin Fixing 51mm (2")



**C1560**  
Screw Fixing 76mm (3")



**C1561**  
Screw Fixing 76mm (3")



**C1566**  
Screw Fixing 76mm (3")



**C1568**  
Self Adhesive 51mm (2")



**C1567**  
Screw Fixing 51mm (2")

# HINGES

To place an order use the correct Reference Number adding the finish required at the end.



eg. When ordering 4" x 4" Parliament Hinges in the Polished Chrome finish, use code HG99-385-PC

Note: Minimum order quantities apply

NE = Natural Brass

DPW = Double Phosphor Washered

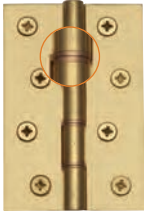
Supplied with screws

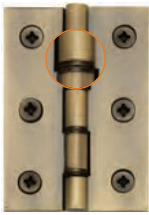
	REF. NO.	DIMENSIONS	Leaf thickness	DESCRIPTION	PC	SC	SN	PE	AT	PN	ME	SE	NE
	HG99-110	1 1/2" x 7/8"	1.2mm	Extruded Brass	•	•	•	•	•	•	•	•	•
	HG99-115	2" x 1 1/8"	1.3mm	Extruded Brass	•	•	•	•	•	•	•	•	•
	HG99-120	2 1/2" x 1 3/8"	1.4mm	Extruded Brass	•	•	•	•	•	•	•	•	•
	HG99-125	3" x 1 5/8"	2.5mm	Extruded Brass	•	•	•	•	•	•	•	•	•
	HG99-130	4" x 2 3/8"	3.0mm	Extruded Brass	•	•	•	•	•	•	•	•	•
	HG99-345	3" x 2"	3.2mm	Double Phosphor Washered	•	•	•	•	•	•	•	•	
	HG99-350	4" x 2 5/8"	3.7mm	Double Phosphor Washered	•	•	•	•	•	•	•	•	
	HG99-355	4" x 3"	4.2mm	Double Phosphor Washered	•	•	•	•	•	•	•	•	
	HG99-385	4" x 2" x 4"	4.0mm	Parliament	•	•	•	•	•	•	•	•	
	HG99-390	4" x 3" x 5"	4.0mm	Parliament	•	•	•	•	•	•	•	•	
	HG99-395	4" x 4" x 6"	4.0mm	Parliament	•	•	•	•	•	•	•	•	
	HG99-400	4" x 3"	3.0mm	Thrust Bearings (Steel Pin)	•	•	•	•	•	•	•	•	
	HG99-405	4" x 4"	3.0mm	Thrust Bearings (Steel Pin)	•	•	•	•	•	•	•	•	
	PR88-400	3" x 2"	2.5mm	Double Phosphor Washered	•	•	•	•	•	•	•	•	
	PR88-405	4" x 2 5/8"	3.5mm	Double Phosphor Washered	•	•	•	•	•	•	•	•	
	PR88-410	4" x 3"	3.5mm	Double Phosphor Washered	•	•	•	•	•	•	•	•	

**BOLTS**

All items all finishes



**C1582**  
1 1/4" Wide  
Straight Bolt  
Sizes: 4" 6" 8"



**C1584**  
1 1/2" Wide  
Straight Bolt  
Sizes: 4" 6" 8"



**C1594**  
1 1/2" Wide  
Necked Bolt  
Sizes: 6"



**C1592**  
1 1/4" Wide  
Necked Bolt  
Sizes: 4" 6"



**C1688**  
Espagnolette Bolt  
1m & 1.5m bar provided



**V1018**  
Thumbturn & Release Diameter 35mm  
with 5mm spindle



**BT5**  
Oval Thumbturn w/o Bolt  
Rose with splined spindle  
Diameter 36mm

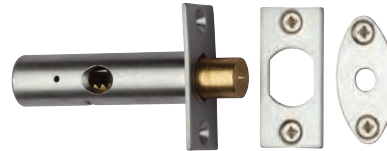

**RB7**  
Rack Bolt  
Backset 33mm



**BT15**  
Thumbturn & Release Diameter 36mm  
with 5mm spindle

**C1680** 3/4" Flush Bolt  
Sizes: 6" 8" 10"



**C1685** Flat Bolt Sizes: 4" 6" 8"



**C1686**  
Slide Bolt 66 x 19mm



**C1530** 4" 6" Cabin Hook  
Sizes:  
4" (102mm)  
6" (152mm)

**C1685 4**

**C1685 6**

**C1685 8**

WINDOW FITTINGS

All items all finishes

**V992 8" 10" 12"**  
Ball Casement Stay 8" (203mm)  
10" (254mm)  
12" (305mm)



**V990 8" 10" 12"**  
Casement Stay 8" (203mm)  
10" (254mm)  
12" (305mm)



**V991**  
Sliding Casement Stay 10" (254mm)



**V1119 6" 10"**  
Roller Arm Stay 6" (150mm)  
10" (254mm)



**V1118**  
Quadrant Stay 152mm



**V1003 MP/HP**  
Mortice & Hook Plate Casement Fastener 126mm  
Suitable for Standard Windows



**V1008 MP/HP**  
Mortice & Hook Plate Ball Casement Fastener 128mm  
Suitable for Weather Stripped Windows



**V1005**  
Locking Casement Fastener 127mm  
Suitable for Standard Windows  
**V1005W**  
Locking Casement Fastener 127mm  
Suitable for Weather Stripped Windows



**V1110**  
Sash Lift 54 x 42mm



**V1117**  
Fanlight Catch Keep 18 x 29mm  
Catch 53 x 29mm



**V1090** Pull Handle Length 152mm  
Length 102mm

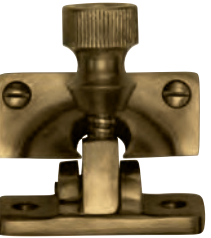

**V2055**  
Brighton Sash Fastener 58 x 23mm



**V1104**  
**V1104L (Lockable)**  
Hook Plate Sash Fastener 69 x 20mm



**V1106**  
**V1106L (Lockable)**  
Hook Plate Sash Fastener 69 x 20mm



**V1105**  
Hook Plate Sash Fastener 69 x 20mm



**V1100**  
Sash Fastener 69 x 20mm



**V2060**  
**V2060L (Lockable)**  
Fitch Pattern Sash Fastener 66 x 17mm



**V1120** Sash Ring Internal Diameter 25mm

## HAT & COAT HOOKS

All items all finishes



**V1040**  
Single Robe Hook  
Projection 43mm



**V1060**  
Double Robe Hook  
Width 64mm



**V1056**  
Hat & Coat Hook  
Projection 86mm



**V1062**  
Double Robe Hook  
Width 78mm



**V1050**  
Hat & Coat Hook  
Height 130mm  
Projection 51mm



**V1044**  
Robe Hook  
Height 45mm  
Projection 62mm



**V1048**  
Hat & Coat Hook  
Height 93mm  
Projection 79mm



**V1064**  
Robe Hook  
Height 52mm  
Projection 44mm



**V1065**  
Hat & Coat Hook  
Height 90mm  
Projection 45mm



**V1079**  
Coat Hooks on Plate  
Width 223mm  
Projection 64mm



**V1030**  
Handrail Bracket  
Projection: 2 1/2" (64mm)  
Projection: 3" (76mm)

## DOOR STOPS

All items all finishes



**V1080**  
Oval Floor Mounted Door Stop  
Base diameter: 47mm  
Base depth: 6mm  
Height: 28mm



**V1088**  
Round Floor Mounted Door Stop  
Base diameter: 38mm  
Base depth: 4mm  
Height: 30mm (including buffer)



**V1089**  
Floor Mounted Door Stop  
30mm Square (including buffer)  
Height: 35mm

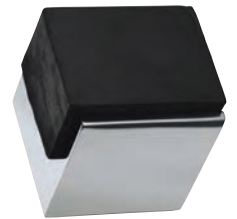

**V1082**  
Floor Mounted Door Stop  
Base: 38 x 38mm  
Top: 38 x 42mm (including buffer)  
Overall Height: 42mm (including buffer)

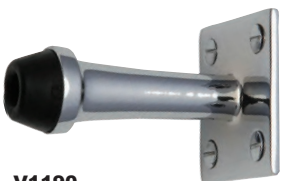

**V1190**  
Wall Mounted Door Stop  
Projection: 64mm  
(including buffer)

**V1190 76**  
Projection: 76mm  
(including buffer)



**V1081 64**  
Cylinder Wall Mounted Door Stop Without Rose  
Projection: 75mm  
(including buffer)

**V1081 76**  
Projection: 87mm  
(including buffer)



**V1084**  
Square Wall Mounted Door Stop  
65 x 16mm  
Projection: 76mm  
(including buffer)



Cylinder Wall Mounted Door Stop With Rose  
**V1192 64**  
Projection: 76mm  
(including buffer)

**V1192 76**  
Projection: 87mm  
(including buffer)



**V1074**  
Gravity Door Latch  
Projection: 83mm





*Large Pull Handles*



## Deco

ITEM	Length	C to C	Projection
V1334 305	305	279	50
V1334 483	483	432	50

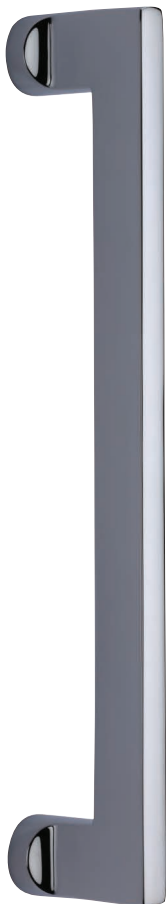

## Apollo

ITEM	Length	C to C	Projection
V4150 305	305	279	58
V4150 457	457	432	58



PULLS



Traditional

ITEM	Length	C to C	Projection
V1376 330	330	279	63
V1376 482	482	432	63



Urban

ITEM	Length	C to C	Projection
V1390 305	305	279	53
V1390 457	457	432	53





## Deco

ITEM	Length	C to C	Projection
V1334 305	305	279	50
V1334 483	483	432	50

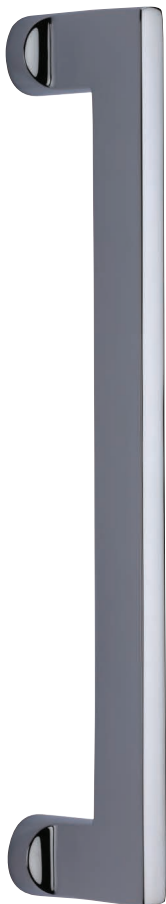

## Apollo

ITEM	Length	C to C	Projection
V4150 305	305	279	58
V4150 457	457	432	58



PULLS



Traditional

ITEM	Length	C to C	Projection
V1376 330	330	279	63
V1376 482	482	432	63



Urban

ITEM	Length	C to C	Projection
V1390 305	305	279	53
V1390 457	457	432	53



PULLS



**V1166**  
Fingerplate  
464 x 76mm

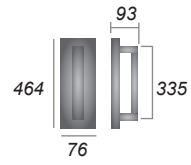

**V1162**  
Pull Handle on Plate

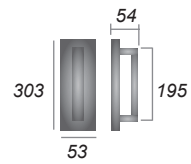

**V1155**  
Pull Handle on Plate



PULLS



278  **V2057**  
Pull Handle



 **COV-12**  
Decorative Bolt Cover  
35mm

245  **V2056**  
Pull Handle



PULLS



ITEM	L	P
V1150 202	202	60
V1150 253	253	63
V1150 310	310	69



**V1150**  
Cranked Pull Handle

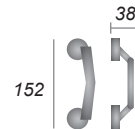

**V1140**  
Bow Pull Handle





# FLUSH PULLS



**RD2322**  
Round Flush Pull  
Diameter 57mm

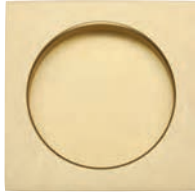

**SQ2327**  
Square Flush Pull  
55 x 55mm

**Also available - Italian Made Push Fit Round & Square Flush Pulls for Pocket Doors**

Available in finishes:



Please view online at [www.m-marcus.com](http://www.m-marcus.com) to see the full range



**C1820**  
Flush Pull Handle

ITEM	L	W
C1820 6	152	51
C1820 4	102	51

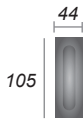
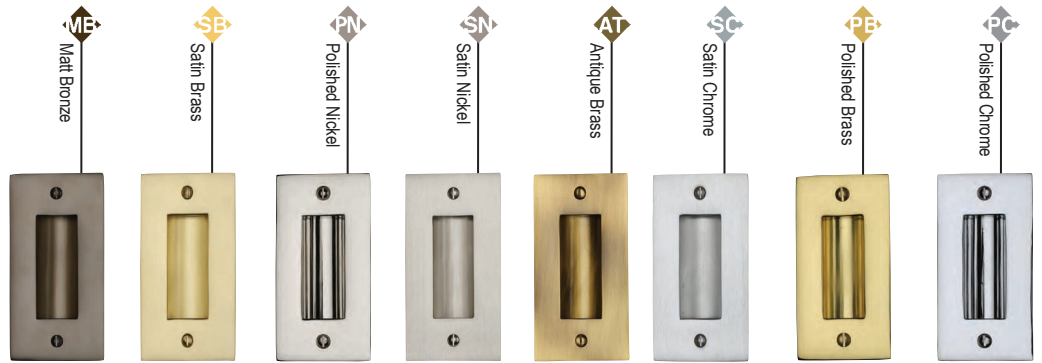

**C1850 105**  
Flush Pull Handle

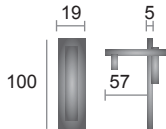

**C1165**  
Pocket Door Edge Pull





Our Cabinet Knobs & Pulls catalogue, available on request, shows our full range of cabinet hardware. May also be viewed online at [www.m-marcus.com](http://www.m-marcus.com)



*Cabinet Knobs & Pulls*

# CABINET KNOBS

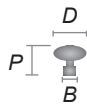

<b>ME</b> Matt Bronze	<b>SE</b> Satin Brass	<b>PN</b> Polished Nickel	<b>SN</b> Satin Nickel	<b>AT</b> Antique Brass	<b>SC</b> Satin Chrome	<b>PE</b> Polished Brass	<b>PC</b> Polished Chrome
ITEM	D	B	P				
C0333 32	32	22	35				

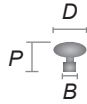
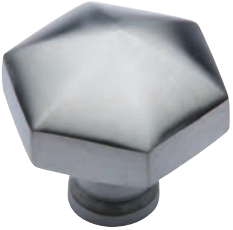

<b>ME</b> Matt Bronze	<b>SE</b> Satin Brass	<b>PN</b> Polished Nickel	<b>SN</b> Satin Nickel	<b>AT</b> Antique Brass	<b>SC</b> Satin Chrome	<b>PE</b> Polished Brass	<b>PC</b> Polished Chrome
ITEM	D	B	P				
C2238	32	15	34				

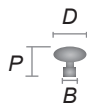

<b>ME</b> Matt Bronze	<b>SE</b> Satin Brass	<b>PN</b> Polished Nickel	<b>SN</b> Satin Nickel	<b>AT</b> Antique Brass	<b>SC</b> Satin Chrome	<b>PE</b> Polished Brass	<b>PC</b> Polished Chrome
ITEM	D	B	P				
C4545	32	16	29				

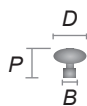

<b>ME</b> Matt Bronze	<b>SE</b> Satin Brass	<b>PN</b> Polished Nickel	<b>SN</b> Satin Nickel	<b>AT</b> Antique Brass	<b>SC</b> Satin Chrome	<b>PE</b> Polished Brass	<b>PC</b> Polished Chrome
ITEM	D	B	P				
C4547	32	12	32				

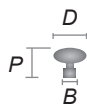

<b>ME</b> Matt Bronze	<b>SE</b> Satin Brass	<b>PN</b> Polished Nickel	<b>SN</b> Satin Nickel	<b>AT</b> Antique Brass	<b>SC</b> Satin Chrome	<b>PE</b> Polished Brass	<b>PC</b> Polished Chrome
ITEM	D	B	P				
C4549	32	16	29				

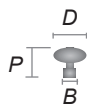

<b>ME</b> Matt Bronze	<b>SE</b> Satin Brass	<b>PN</b> Polished Nickel	<b>SN</b> Satin Nickel	<b>AT</b> Antique Brass	<b>SC</b> Satin Chrome	<b>PE</b> Polished Brass	<b>PC</b> Polished Chrome
ITEM	D	B	P				
C2234	35	13	33				

# CABINET KNOBS

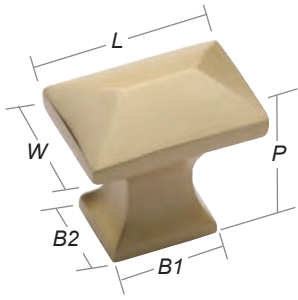

Pyramid Knob

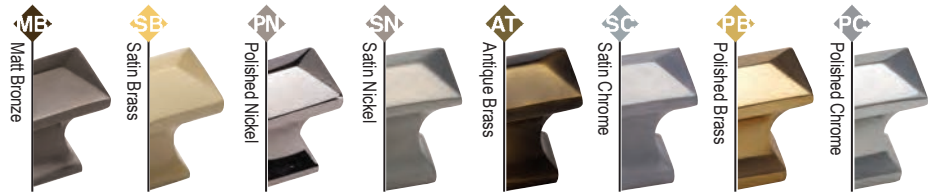

ITEM	L	B1	B2	W	P
C2232	35	22	17	22	38

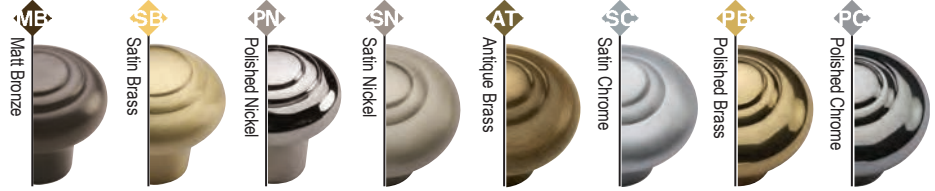
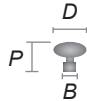

ITEM	D	B	P
C3985 32	32	15	30
C3985 38	38	16	32

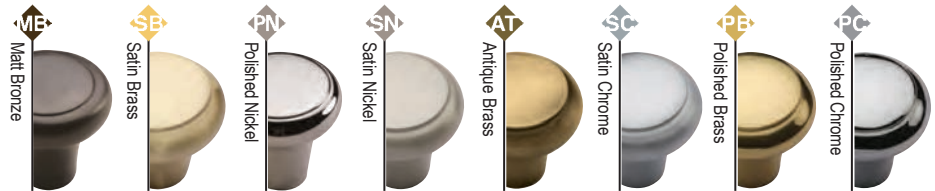
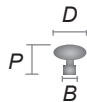

ITEM	D	B	P
C3990 32	32	14	30
C3990 38	38	16	32



Round Stepped Cabinet Knob

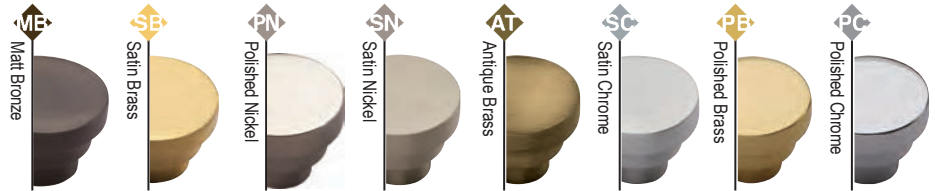
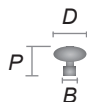

ITEM	D	B	P
C3624 32	32	16	24
C3624 38	38	22	24



Square Stepped Cabinet Knob

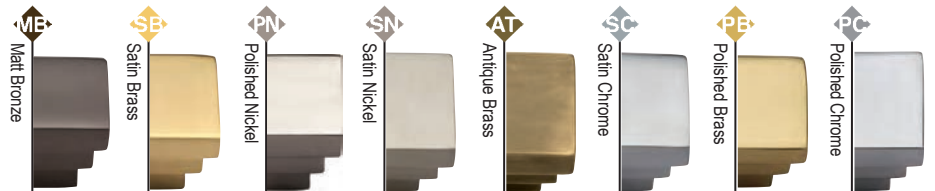
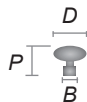

ITEM	D	B	P
C3672 32	32	17	25

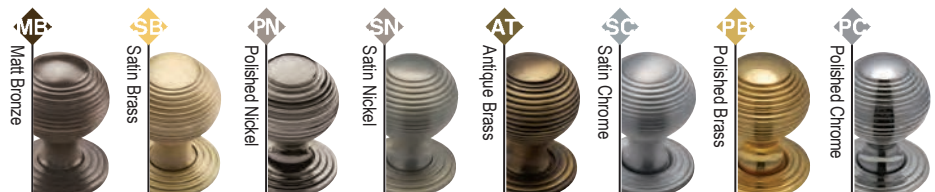
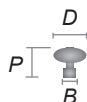

ITEM	D	B	P
V973 32	32	32	43

# CABINET KNOBS

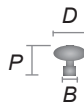

ME Matt Bronze	SE Satin Brass	PN Polished Nickel	SN Satin Nickel	AT Antique Brass	SC Satin Chrome	PE Polished Brass	PC Polished Chrome
ITEM	D	B	P				
C2240 25	25	25	23				
C2240 32	32	32	28				
C2240 38	38	38	33				
C2240 48	48	48	42				

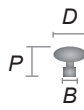

ME Matt Bronze	SE Satin Brass	PN Polished Nickel	SN Satin Nickel	AT Antique Brass	SC Satin Chrome	PE Polished Brass	PC Polished Chrome
ITEM	D	B	P				
C114 32	32	15	28				
C114 38	38	15	32				

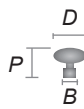

ME Matt Bronze	SE Satin Brass	PN Polished Nickel	SN Satin Nickel	AT Antique Brass	SC Satin Chrome	PE Polished Brass	PC Polished Chrome
ITEM	D	B	P				
C113 32	32	15	29				
C113 38	38	16	32				

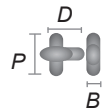

Showcase Fastener

ME Matt Bronze	SE Satin Brass	PN Polished Nickel	SN Satin Nickel	AT Antique Brass	SC Satin Chrome	PE Polished Brass	PC Polished Chrome
ITEM	D	B	P				
V1970	37	16	55				



Oval Cabinet Knob & Backplate

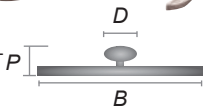

ME Matt Bronze	SE Satin Brass	PN Polished Nickel	SN Satin Nickel	AT Antique Brass	SC Satin Chrome	PE Polished Brass	PC Polished Chrome
ITEM	D	B	P				
C3072 32	32	162	32				



Round Cabinet Knob & Backplate

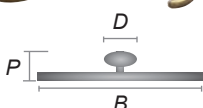

ME Matt Bronze	SE Satin Brass	PN Polished Nickel	SN Satin Nickel	AT Antique Brass	SC Satin Chrome	PE Polished Brass	PC Polished Chrome
ITEM	D	B	P				
C3074 32	32	162	32				

# CABINET DROPS



<b>ME</b> Matt Bronze	<b>SE</b> Satin Brass	<b>PN</b> Polished Nickel	<b>SN</b> Satin Nickel	<b>AT</b> Antique Brass	<b>SC</b> Satin Chrome	<b>PE</b> Polished Brass	<b>PC</b> Polished Chrome
ITEM V5023		Height 92	Width 30	Projection 13			



<b>ME</b> Matt Bronze	<b>SE</b> Satin Brass	<b>PN</b> Polished Nickel	<b>SN</b> Satin Nickel	<b>AT</b> Antique Brass	<b>SC</b> Satin Chrome	<b>PE</b> Polished Brass	<b>PC</b> Polished Chrome
ITEM V5025		Height 66	Width 34	Projection 13			



<b>ME</b> Matt Bronze	<b>SE</b> Satin Brass	<b>PN</b> Polished Nickel	<b>SN</b> Satin Nickel	<b>AT</b> Antique Brass	<b>SC</b> Satin Chrome	<b>PE</b> Polished Brass	<b>PC</b> Polished Chrome
ITEM V5021		Height 40	Width 90				



<b>ME</b> Matt Bronze	<b>SE</b> Satin Brass	<b>PN</b> Polished Nickel	<b>SN</b> Satin Nickel	<b>AT</b> Antique Brass	<b>SC</b> Satin Chrome	<b>PE</b> Polished Brass	<b>PC</b> Polished Chrome
ITEM C6321		Ø 50					



<b>ME</b> Matt Bronze	<b>SE</b> Satin Brass	<b>PN</b> Polished Nickel	<b>SN</b> Satin Nickel	<b>AT</b> Antique Brass	<b>SC</b> Satin Chrome	<b>PE</b> Polished Brass	<b>PC</b> Polished Chrome
ITEM C6311		D 50	B 50				

# DRAWER PULLS

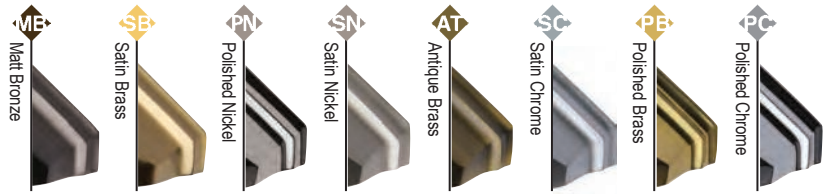

ITEM	Length	CTC	Projection
C2768	104	89	33

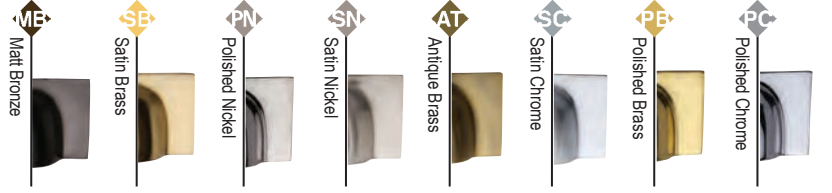

ITEM	Length	CTC	Projection
C2766	145	96	22
C2766	221	152	22

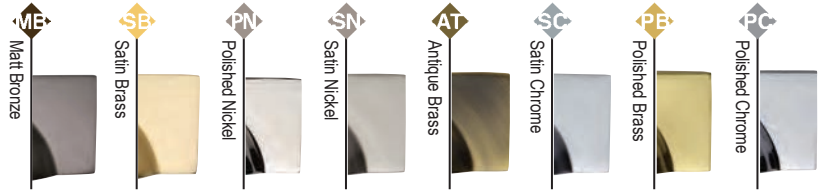

ITEM	Length	CTC	Projection
C2764	112	57	21

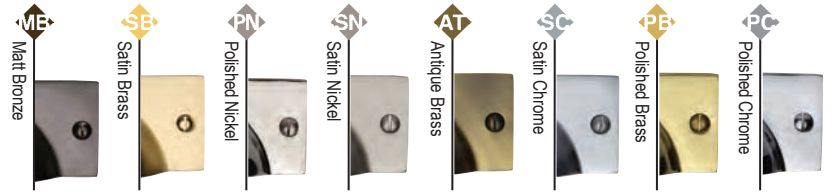

ITEM	Length	Projection
C2762	112	21

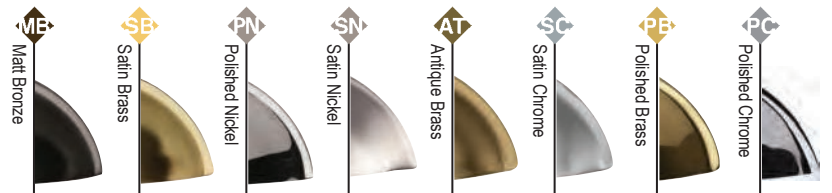

ITEM	Length	CTC	Projection
C2760	85	57	18

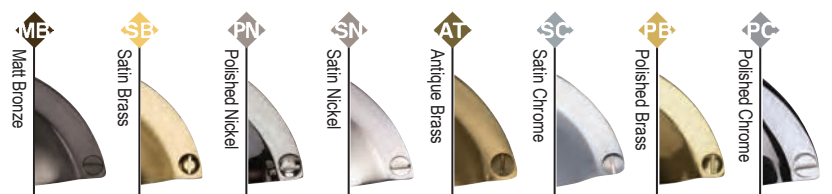

ITEM	Length	Projection
C1700	97	18

# CABINET PULLS

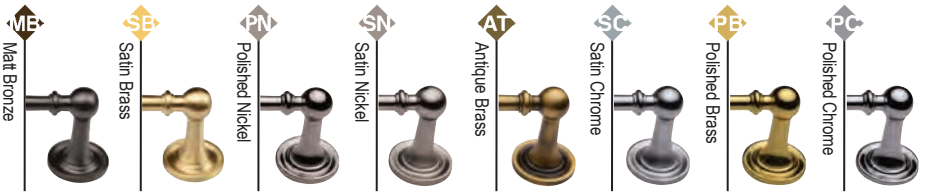

ITEM	Length	CTC	Base Ø	Projection
C2533 96	121	96	25	38
C2533 152	177	152	25	38
C2533 203	228	203	25	38
C2533 254	280	254	25	38

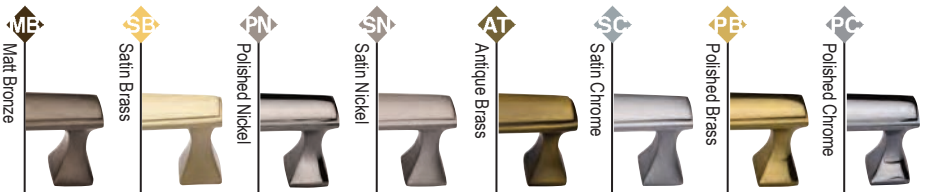

ITEM	Length	CTC	Projection
C0334 96	113	96	35
C0334 160	177	160	35
C0334 203	220	203	35
C0334 254	271	254	35

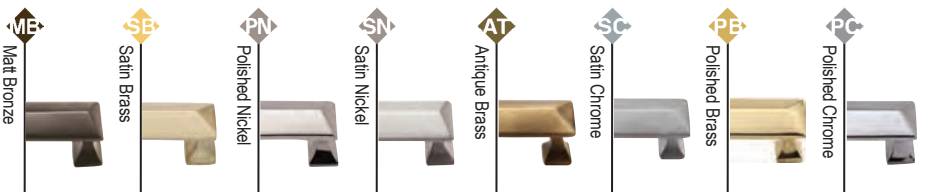

ITEM	Length	CTC	Projection
C2231 96	113	96	35
C2231 152	169	152	35
C2231 203	220	203	35

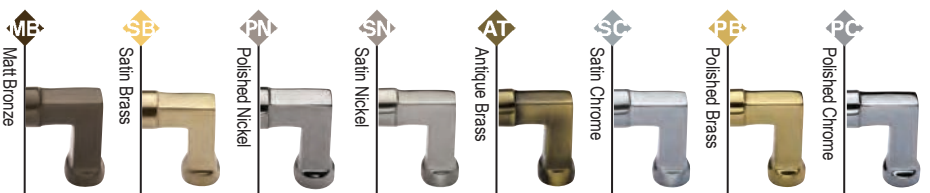

ITEM	Length	CTC	Projection	Ø
C0312 101	117	101	40	15
C0312 160	175	160	40	15
C0312 203	218	203	40	15
C0312 254	269	254	40	15

Bauhaus



# CABINET PULLS



ME Matt Bronze SE Satin Brass PN Polished Nickel SN Satin Nickel AT Antique Brass SC Satin Chrome PE Polished Brass PC Polished Chrome

ITEM	Length	CTC	Projection
C0339 96	106	96	30
C0339 160	170	160	30
C0339 256	266	256	30



ME Matt Bronze SE Satin Brass PN Polished Nickel SN Satin Nickel AT Antique Brass SC Satin Chrome PE Polished Brass PC Polished Chrome

ITEM	Length	CTC	Width	Projection
C0337 96	116	96	10	30
C0337 160	172	160	10	30
C0337 203	223	203	10	30
C0337 254	274	254	10	30



ME Matt Bronze SE Satin Brass PN Polished Nickel SN Satin Nickel AT Antique Brass SC Satin Chrome PE Polished Brass PC Polished Chrome

ITEM	Length	CTC	Projection
C0345 96	115	96	35
C0345 160	179	160	35
C0345 203	222	203	35



ME Matt Bronze SE Satin Brass PN Polished Nickel SN Satin Nickel AT Antique Brass SC Satin Chrome PE Polished Brass PC Polished Chrome

ITEM	Length	CTC	Width	Projection
C4520 101	110	101	20	28
C4520 160	168	160	20	28
C4520 203	211	203	20	28



ME Matt Bronze SE Satin Brass PN Polished Nickel SN Satin Nickel AT Antique Brass SC Satin Chrome PE Polished Brass PC Polished Chrome

ITEM	Length	CTC	Projection
C1800 89	97	89	32
C1800 152	160	152	32
C1800 203	211	203	32

# CABINET PULLS



Bar

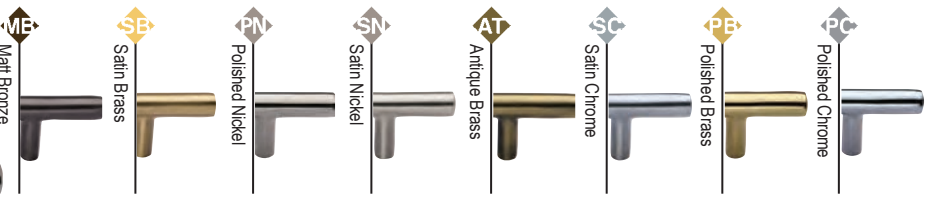

ITEM	Length	CTC	Projection	Ø
C0361 101	165	101	32	11
C0361 160	224	160	32	11
C0361 203	267	203	32	11

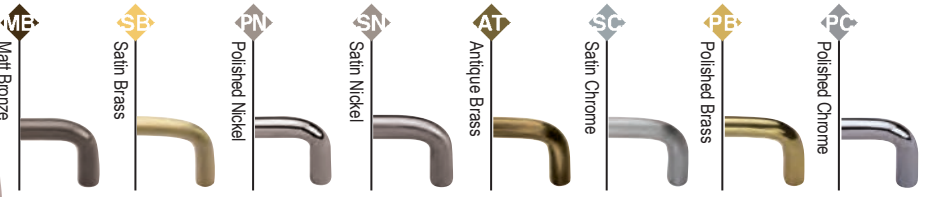
ITEM	Length	CTC	Projection	Ø
C2155 96	104	96	32	8
C2155 160	168	160	32	8



Durham

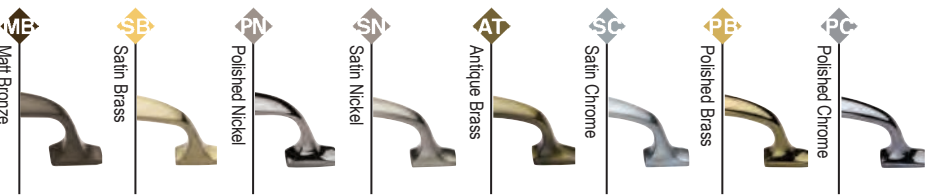

ITEM	Length	CTC	Projection
C7213 76	99	76	31
C7213 160	184	160	35
C7213 203	228	203	35

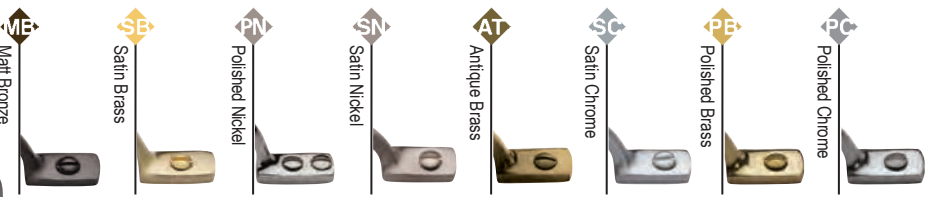
ITEM	Length	Projection
V1090 102	102	28
V1090 152	152	35

ITEM	Length	CTC	Projection	Ø
C0376 96	127	96	32	11
C0376 152	181	152	32	11
C0376 203	232	203	32	11

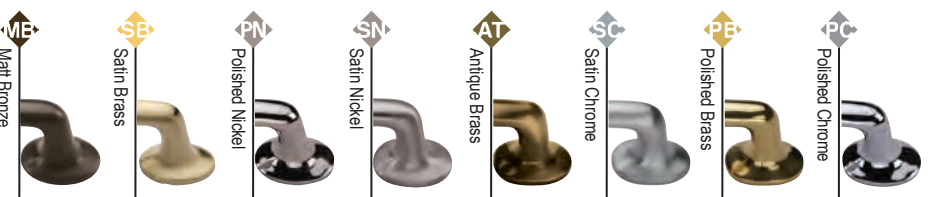

## *Solid Bronze Rustic*

These striking products are made using molten Bronze flowing into cavities within a sand mould. This casting process leaves light surface indentations to bestow a rustic appearance, which contrasts in texture to other smoothly finished products. A light bronze patina is applied by hand on the cast bronze creating a country-style appearance. Over a period of time the bronze colour will lighten along any edges and surfaces that are frequently touched creating a naturally aged appearance as the bronze below is slowly exposed. When untouched, the finish may darken as the bronze oxidises. As this is a living finish, products will not be identical, there will be slight variation in hue and tone.



### Bridgnorth

- RBL2500** Lever Lock
- RBL2510** Lever Latch
- RBL2530** Bathroom Set
- RBL2548** Euro Profile

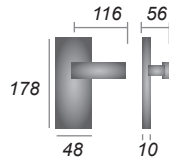

### Cheswell

- RBL3100** Lever Lock
- RBL3110** Lever Latch
- RBL3130** Bathroom Set
- RBL3148** Euro Profile

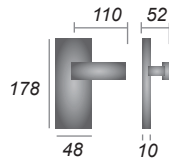

### Ashfield

- RBL3700** Lever Lock
- RBL3710** Lever Latch
- RBL3730** Bathroom Set
- RBL3748** Euro Profile

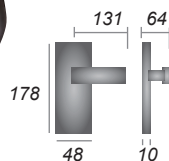

### Hadley

- RBL4700** Lever Lock
- RBL4710** Lever Latch
- RBL4730** Bathroom Set
- RBL4748** Euro Profile
- RBL4792.C122** Multi-Point
- RBL4792.T215** Multi-Point
- This plate is longer at 245mm

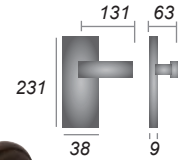

### Grafton

- RBL4400** Lever Lock
- RBL4410** Lever Latch
- RBL4430** Bathroom Set
- RBL4448** Euro Profile
- RBL4492.C122** Multi-Point
- RBL4492.T215** Multi-Point
- This plate is longer at 245mm

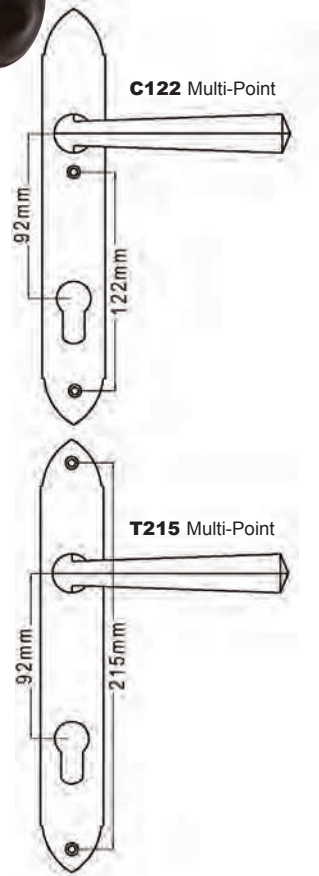
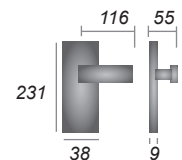



### Ironbridge

- RBL3600** Lever Lock
- RBL3610** Lever Latch
- RBL3630** Bathroom Set
- RBL3648** Euro Profile

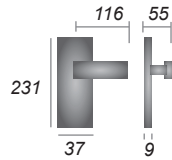

### Claverley

**RBL1933**

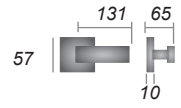

### Donnington

**RBL1953**

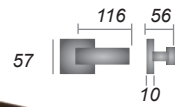

### Hanwood

**RBL5410**

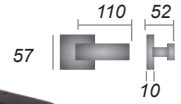

### Ludlow

- RBL5800** Lever Lock
- RBL5810** Lever Latch
- RBL5830** Bathroom Set
- RBL5848** Euro Profile

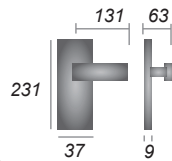

Size 45 x 45mm



**RBL155**  
Turn and Release



**RBL158**  
Euro Profile

**RBL159**  
Key Escutcheon

## EXTERNAL DOOR HARDWARE



**RBL465.10 1/2"**  
Letter Plate  
Size: 265 x 106mm  
C to C 242mm  
Aperture: 205 x 46mm



**RBL467.13 1/2"**  
Letter Plate  
Size: 343 x 96mm  
C to C 292mm  
Aperture: 235 x 46mm



**RBL862 270**  
Interior Letterflap  
Size: 270 x 88mm  
For letter plates up to 12"

**RBL862 348**  
Interior Letterflap  
Size: 348 x 88mm  
For letter plates up to 14"



Door Hinge

**RBL414 308**  
Size: 12", 308mm

**RBL414 381**  
Size: 15", 381mm

**RBL414 457**  
Size: 18", 457mm

# 0123456789

**RBL351**  
Screw Fixing 76mm (3")



**RBL339**  
Ring Knocker  
Inner diameter inner: 77mm  
Outer diameter : 107mm



**RBL338**  
Slim Knocker  
167 x 40mm



**RBL901**  
Centre Door Knob

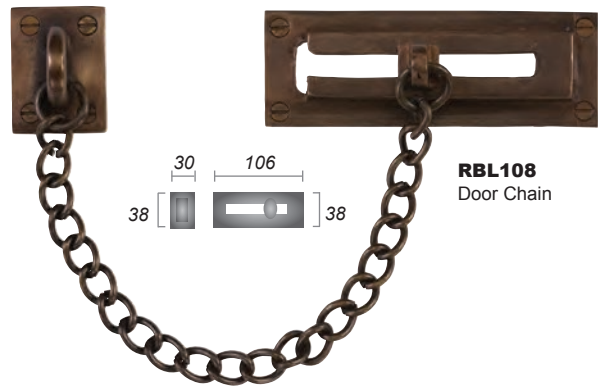

**RBL108**  
Door Chain

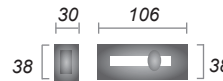

**RBL431**  
Finger Plate  
Size: 12 x 2 1/2"



**RBL342**  
Cylinder Pull  
Size: 90 x 46mm



**RBL791**  
Studs  
• 19mm  
• 40mm



**RBL348**  
Bell Push  
Size:  
103 x 32mm

## WINDOW FITTINGS



Casement Stay

**RBL680 254** 10" 254mm

**RBL680 305** 12" 305mm



**RBL1111**

Sash Lift  
Size: 54 x 42mm

**RBL682 MP/HP**  
Mortice and Hook Plate  
Casement Fastener

Length: 128mm  
Projection: 28mm

**RBL684 MP/HP**  
Mortice and Hook Plate  
Casement Fastener

**RBL684 is suitable for  
weather stripped windows**

Length: 128mm  
Projection: 41mm



See page 54



**RBL992 8" 10" 12"**  
Ball Casement Stay



**RBL1008 MP/HP**  
Mortice & Hook Plate  
Ball Casement Fastener 128mm  
Suitable for  
**Weather Stripped Windows**

## GATE LATCHES



**RBL568**

Gate handle and latch  
Handle height: 212mm  
Latch length: 238mm



**RBL571**

Gate handle and latch  
Handle: 218 x 50mm  
Latch length: 218mm



**RBL541**

Ring Handle and latch  
Handle diameter: 60mm  
Latch length: 170mm



## MORTICE KNOBS DOOR FURNITURE



**Knowle**  
**RBL4555**



**RBL555**  
Turn and Release



**Alveley**  
**RBL4975**



**RBL556**  
Euro Profile  
Diameter 45mm



**RBL553**  
Key Escutcheon  
Diameter 45mm



**RBL554**  
Covered Escutcheon  
Diameter 45mm  
Suitable for use on  
**Mortice Deadbolts Only**

• All mortice knobs on this page are unsprung and will need to be installed with a 3" heavy duty latch

## COAT HOOKS AND DOOR FURNITURE ACCESSORIES



**RBL157**  
Coat Hook



**RBL156**  
Coat Hook



**RBL121**  
Door Stop

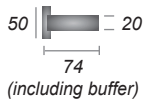

**RBL154**  
Cabin Hook  
• 106mm  
• 153mm

**RBL2571**  
Door Bolt  
• 6" 152mm  
• 8" 203mm



**RBL1685**  
Door Bolt  
• 6" 152mm  
• 8" 203mm



PULL HANDLES



**RBL346 Bauhaus**  
Pull Handle

CODE	C to C	Length	Projection
RBL346 227	203	227	62
RBL346 305	281	305	62
RBL346 457	432	457	66



**RBL349**  
Pull Handle

CODE	C to C	Length	Projection
RBL349 227	140	227	56
RBL349 305	184	305	56
RBL349 457	292	457	62



CABINET HARDWARE



**RBL1150**  
Cranked Pull Handle

CODE	Length	Projection
RBL1150 254	254	55
RBL1150 305	305	62



**RBL3622**

Diameter	Projection
32	27



**RBL6389**

Height	Width
67	57
Ring Diameter 42	



**RBL3880**

Diameter	Projection
32	24
38	24



**RBL3985**

Diameter	Projection
32	32
38	35

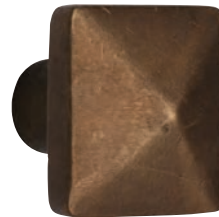

**RBL390**

Diameter	Projection
32	30
38	32



**RBL3990**

Diameter	Projection
32	30
38	35



**RBL3674**

Diameter	Projection
32	24
38	24



**RBL179**

Diameter	Projection
32	32
38	35



**RBL3894**

Diameter	Projection
25	22



**RBL613**

Diameter	Projection
25	30
32	34
38	38

# CABINET PULLS



**RBL376**

CODE	C to C	Length	Projection
RBL376 96	96	125	32
RBL376 152	152	184	32
RBL376 203	203	235	32



**RBL331**

CODE	C to C	Length	Projection
RBL331 96	96	108	35
RBL331 152	152	165	35



**RBL340**

CODE	C to C	Length	Projection
RBL340 96	96	114	38
RBL340 152	152	172	38



**RBL337**

CODE	C to C	Length	Projection
RBL337 96	96	114	30
RBL337 152	152	171	30
RBL337 203	203	222	30
RBL337 254	254	273	30

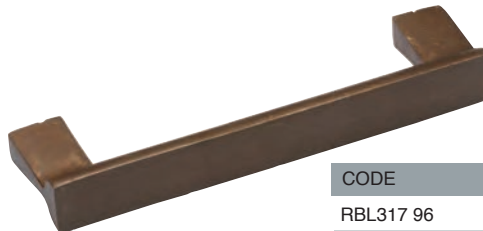

**RBL317**

CODE	C to C	Length	Projection
RBL317 96	96	114	30
RBL317 152	152	171	30



**RBL1090**

CODE	C to C	Length	Projection
RBL1090 102	~	102	25
RBL1090 152	~	152	36
RBL1090 203	~	203	36
RBL1090 254	~	254	36



**RBL301**

CODE	C to C	Length	Projection
RBL301 96	96	133	36
RBL301 140	140	190	36
RBL301 178	178	241	36
RBL301 216	216	292	36



**RBL1092**

CODE	C to C	Length	Projection
RBL1092 102	~	102	27
RBL1092 152	~	152	27
RBL1092 203	~	203	27
RBL1092 254	~	254	27



**RBL361**

CODE	C to C	Length	Projection
RBL361 96	96	133	35
RBL361 140	140	191	35



**RBL1145**

CODE	C to C	Length	Projection
RBL1145 159	~	159	36
RBL1145 210	~	210	36



**RBL345**

CODE	C to C	Length	Projection
RBL345 96	96	114	35
RBL345 152	152	171	35
RBL345 203	203	222	35



## *Black Iron Rustic*

Using traditional sand casting methods to create contemporary designs, this range of Malleable Iron hardware is unique, combining rustic charm with current trends.

### Bridgnorth

- FB2500** Lever Lock
- FB2510** Lever Latch
- FB2530** Bathroom Set
- FB2548** Euro Profile

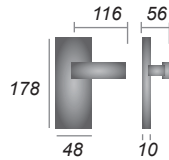

### Hadley

- FB4700** Lever Lock
- FB4710** Lever Latch
- FB4730** Bathroom Set
- FB4748** Euro Profile
- FB4792.C122** Multi-Point
- FB4792.T215** Multi-Point
- This plate is longer at 245mm

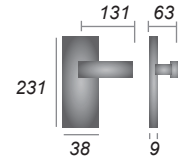

### Cheswell

- FB3100** Lever Lock
- FB3110** Lever Latch
- FB3130** Bathroom Set
- FB3148** Euro Profile

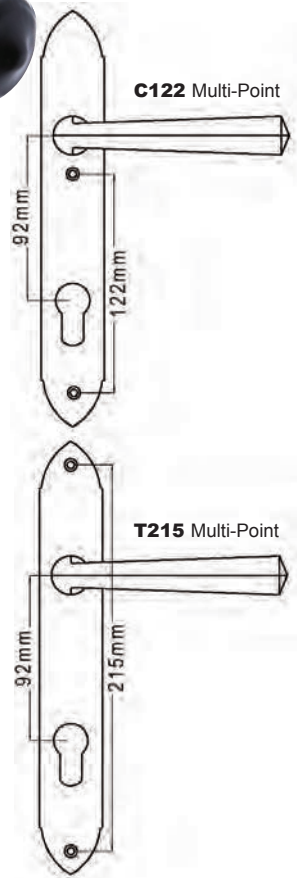
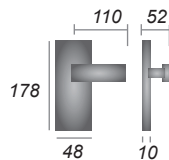

### Ashfield

- FB3700** Lever Lock
- FB3710** Lever Latch
- FB3730** Bathroom Set
- FB3748** Euro Profile

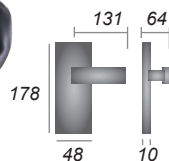

### Grafton

- FB4400** Lever Lock
- FB4410** Lever Latch
- FB4430** Bathroom Set
- FB4448** Euro Profile
- FB4492.C122** Multi-Point
- FB4492.T215** Multi-Point
- This plate is longer at 245mm

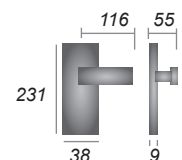



### Ironbridge

- FB3600** Lever Lock
- FB3610** Lever Latch
- FB3630** Bathroom Set
- FB3648** Euro Profile

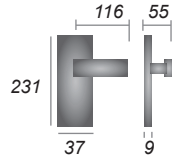

### Claverley

**FB1933**

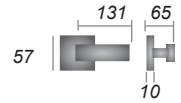

### Donnington

**FB1953**

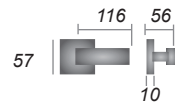

### Hanwood

**FB5410**

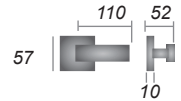

### Ludlow

- FB5800** Lever Lock
- FB5810** Lever Latch
- FB5830** Bathroom Set
- FB5848** Euro Profile

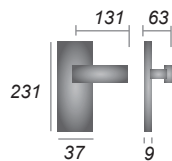

Size 45 x 45mm



**FB155**  
Turn and Release



**FB158**  
Euro Profile

**FB159**  
Key Escutcheon

EXTERNAL DOOR HARDWARE



**FB465.10 1/2"**  
Letter Plate  
Size: 265 x 106mm  
C to C 242mm  
Aperture: 205 x 46mm



**FB467.13 1/2"**  
Letter Plate  
Size: 343 x 96mm  
C to C 292mm  
Aperture: 235 x 46mm



**FB862 270**  
Interior Letterflap  
Size: 270 x 88mm  
For letter plates up to 12"  
**FB862 348**  
Interior Letterflap  
Size: 348 x 88mm  
For letter plates up to 14"



Door Hinge  
**FB414 308**  
Size: 12", 308mm  
**FB414 381**  
Size: 15", 381mm  
**FB414 457**  
Size: 18", 457mm



Decorative Door Hinge  
**FB416 308**  
Size: 12", 308mm  
**FB416 400**  
Size: 15 1/2", 400mm



# 0123456789

**FB351**  
Screw Fixing 76mm (3")



**FB339**  
Ring Knocker  
Inner diameter inner: 77mm  
Outer diameter : 107mm



**FB338**  
Slim Knocker  
167 x 40mm

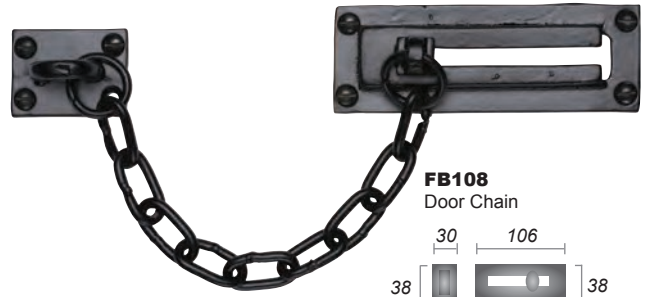

**FB901**  
Centre Door Knob

 A technical drawing showing the dimensions of the knob: a diameter of 80mm and a depth of 69mm.

**FB108**  
Door Chain

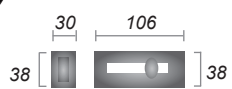
 A technical drawing showing the dimensions of the chain: a width of 30mm, a length of 106mm, and a depth of 38mm.

**FB431**  
Finger Plate  
Size: 12 x 2 1/2"



**FB342**  
Cylinder Pull  
Size: 90 x 46mm



**FB791**  
Studs  
• 19mm  
• 40mm



**FB348**  
Bell Push  
Size:  
103 x 32mm

## WINDOW FITTINGS



Casement Stay

**FB680 254** 10" 254mm

**FB680 305** 12" 305mm



**FB682 MP/HP**  
Mortice and Hook Plate  
Casement Fastener

Length: 128mm  
Projection: 28mm

**FB684 MP/HP**  
Mortice and Hook Plate  
Casement Fastener

**FB684 is suitable for  
weather stripped windows**

Length: 128mm  
Projection: 41mm



**FB1111**  
Sash Lift  
Size: 54 x 42mm

See page 54



**FB992 8" 10" 12"**  
Ball Casement Stay



**FB1008 MP/HP**  
Mortice & Hook Plate  
Ball Casement Fastener 128mm  
Suitable for  
Weather Stripped Windows

## GATE LATCHES

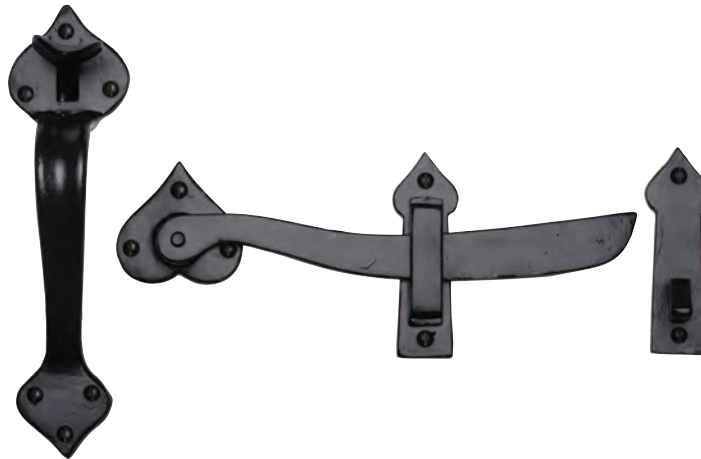

**FB568**  
Gate handle and latch  
Handle height: 212mm  
Latch length: 238mm

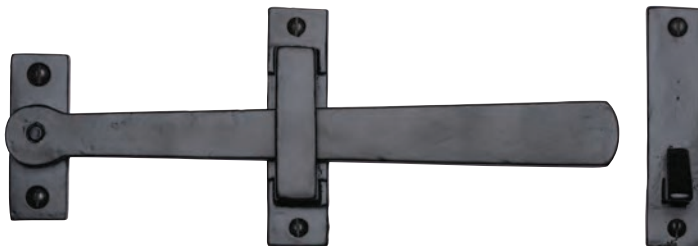

**FB571**  
Gate handle and latch  
Handle: 218 x 50mm  
Latch length: 218mm

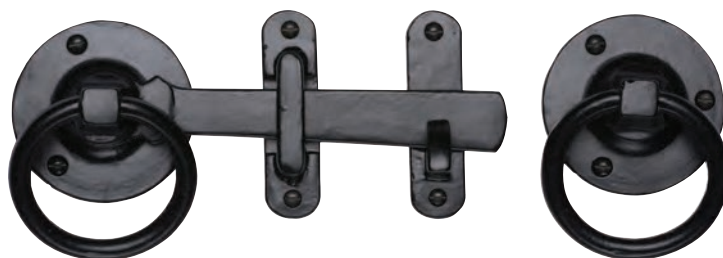

**FB541**  
Ring Handle and latch  
Handle diameter: 72mm  
Latch length: 170mm

## MORTICE KNOBS DOOR FURNITURE



**Knowle**  
**FB4555**



**FB555**  
Turn and Release



**Alveley**  
**FB4975**



**FB556**  
Euro Profile  
Diameter 45mm



**FB553**  
Key Escutcheon  
Diameter 45mm



**FB554**  
Covered Escutcheon  
Diameter 45mm  
Suitable for use on  
**Mortice Deadbolts Only**

• All mortice knobs on this page are unsprung and will need to be installed with a 3" heavy duty latch

## COAT HOOKS AND DOOR FURNITURE ACCESSORIES



**FB157**  
Coat Hook



**FB156**  
Coat Hook



**FB121**  
Door Stop

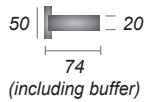

**FB1685**  
Door Bolt  
• 6" 152mm  
• 8" 203mm



**FB154**  
Cabin Hook  
• 106mm  
• 153mm

PULL HANDLES



**FB346 Bauhaus**  
Pull Handle

CODE	C to C	Length	Projection
FB346 227	203	227	62
FB346 305	281	305	62
FB346 457	432	457	66



**FB349**  
Pull Handle

CODE	C to C	Length	Projection
FB349 227	140	227	56
FB349 305	184	305	56
FB349 457	292	457	62



CABINET HARDWARE



**FB1150**  
Cranked Pull Handle

CODE	Length	Projection
FB1150 254	254	55
FB1150 305	305	62



**FB3622**

Diameter	Projection
32	27



**FB6389**

Height	Width
67	57
Ring Diameter 42	



**FB3880**

Diameter	Projection
32	24
38	24



**FB3985**

Diameter	Projection
32	32
38	35



**FB390**

Diameter	Projection
32	30
38	32



**FB3990**

Diameter	Projection
32	30
38	35



**FB3674**

Diameter	Projection
32	24
38	24



**FB179**

Diameter	Projection
32	32
38	35



**FB3894**

Diameter	Projection
25	22



**FB613**

Diameter	Projection
25	30
32	34
38	38

# CABINET PULLS



**FB376**

CODE	C to C	Length	Projection
FB376 96	96	125	32
FB376 152	152	184	32
FB376 203	203	235	32
FB376 254	254	286	32



**FB331**

CODE	C to C	Length	Projection
FB331 96	96	108	35
FB331 152	152	165	35
FB331 203	203	216	35
FB331 254	254	267	35



**FB341**

CODE	C to C	Length	Projection
FB341 96	96	108	32
FB341 152	152	165	32
FB341 203	203	216	32
FB341 254	254	267	32



**FB337**

CODE	C to C	Length	Projection
FB337 96	96	114	30
FB337 152	152	171	30
FB337 203	203	222	30



**FB1090**

CODE	C to C	Length	Projection
FB1090 102	~	102	25
FB1090 152	~	152	36
FB1090 203	~	203	36
FB1090 254	~	254	36



**FB317**

CODE	C to C	Length	Projection
FB317 96	96	114	30
FB317 152	152	171	30
FB317 203	203	222	30

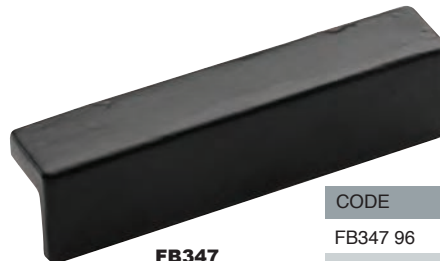

**FB347**

CODE	C to C	Length	Projection
FB347 96	96	114	21
FB347 152	152	171	21
FB347 203	203	222	21



**FB1092**

CODE	C to C	Length	Projection
FB1092 102	~	102	27
FB1092 152	~	152	27
FB1092 203	~	203	27
FB1092 254	~	254	27



**FB361**

CODE	C to C	Length	Projection
FB361 96	96	133	35
FB361 140	140	191	35
FB361 178	178	241	35
FB361 216	216	292	35



**FB1145**

CODE	C to C	Length	Projection
FB1145 159	~	159	36
FB1145 210	~	210	36
FB1145 260	~	260	36



**FB345**

CODE	C to C	Length	Projection
FB345 96	96	114	35
FB345 152	152	171	35
FB345 203	203	222	35
FB345 254	254	273	35



## *Tudor Collection*

A collection of durable malleable iron door hardware products.  
The black powder coated finish on traditional designs provide an appearance ideal for restoration projects.



### The Wroxeter

168 x 51mm

- TC800** Lever Lock
- TC810** Lever Latch
- TC820** Bathroom Set



### The Shropshire

155 x 49mm

- TC100** Lever Lock
- TC110** Lever Latch
- TC120** Bathroom Set
- TC148** Euro Profile



### Fleur de Lys

200 x 51mm

- TC200** Lever Lock
- TC210** Lever Latch
- TC220** Bathroom Set



### The Windsor

138 x 44mm

- TC500** Lever Lock
- TC513** Lever Latch 102 x 44mm
- TC530** Bathroom Set
- TC548** Euro Profile





### The Wellington

146 x 39mm

- TC600** Lever Lock
- TC610** Lever Latch
- TC620** Bathroom Set
- TC648** Euro Profile



### Oval Mortice Knob

**TC550**  
Base 70 x 51mm  
Knob 63 x 38mm

- These mortice knobs are unsprung and will need to be installed with a 3" heavy duty latch



### Ball Mortice Knob

**TC970**  
Base diameter 62mm  
Knob diameter 47mm



**TC542**  
Covered  
Escutcheon  
57 x 30mm



**TC545**  
Escutcheon  
79 x 28mm



**TC547**  
Euro Profile  
Escutcheon  
60 x 40mm



**TC544**  
Escutcheon  
49 x 31mm



### The Colonial

155 x 53mm

- TC300** Lever Lock
- TC315** Lever Latch
- TC310** Lever Latch  
132 x 50mm
- TC320** Bathroom Set
- TC348** Euro Profile



**TC686**  
Thumbturn & Re-  
lease  
Diameter 35mm  
with 5mm spindle

**TC430**  
Finger Plate  
301 x 65mm



EXTERNAL DOOR HARDWARE



**TC340** Cyl-  
inder Pull  
74 x 44mm



**TC540**  
Cylinder Cover  
138 x 60mm



**TC345**  
Bell Push  
125 x 33mm

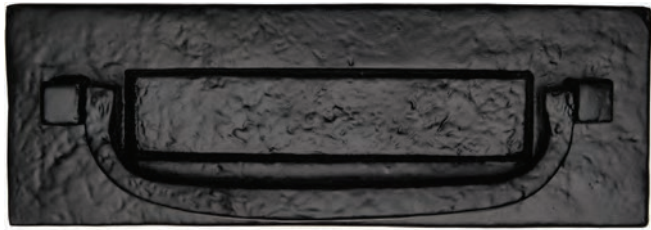

**TC562** Letter Plate with Knocker  
302 x 109mm - CtoC 250mm  
Aperture 193 x 45mm



**TC365 10"** Letter Plate  
254 x 76mm  
CtoC 225mm  
Aperture 202 x 43mm

**TC365 10 1/2"** Letter Plate  
262 x 108mm  
CtoC 230mm  
Aperture 197 x 45mm

**TC365 13 1/2"** Letter Plate  
343 x 96mm  
CtoC 300mm  
Aperture 240 x 55mm



**TC107**  
Door Chain  
138 x 82mm



**TC350**  
Centre Door Knob  
Base diameter: 64mm  
Knob diameter: 63mm  
Projection: 64mm



**TC335**  
Ring Knocker  
127mm



**TC770** Letter Plate *Fleur de Lys*  
362 x 79mm - CtoC 238mm  
Aperture 197 x 43mm

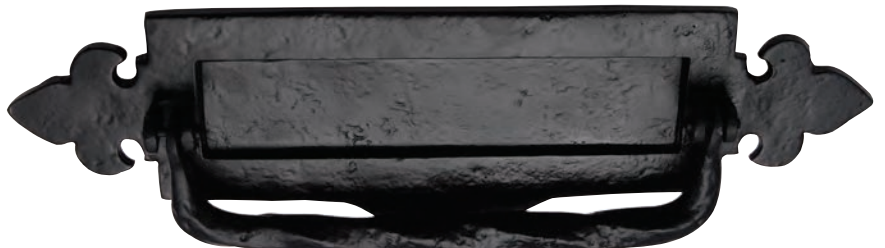

**TC772** Letter Plate *Fleur de Lys* with Knocker  
371 x 112mm - CtoC 285mm  
Aperture 208 x 48mm



**TC539**  
Knocker  
204 x 107mm



**TC860** Interior Letterflap 256 x 84mm  
For letter plates up to 10"

**TC355**  
Numerals 102mm



**TC356**  
Numerals 76mm



LATCHES AND BOLTS



This Product is Handed  
RH shown

**TC570RH**  
**TC570LH**  
Ring Handle diameter: 75mm  
Gate Latch width: 152mm  
Gate Latch height: 102mm



**TC165** Door Bolt Straight  
113mm



**TC168** Door Bolt Straight  
• 86mm  
• 110mm

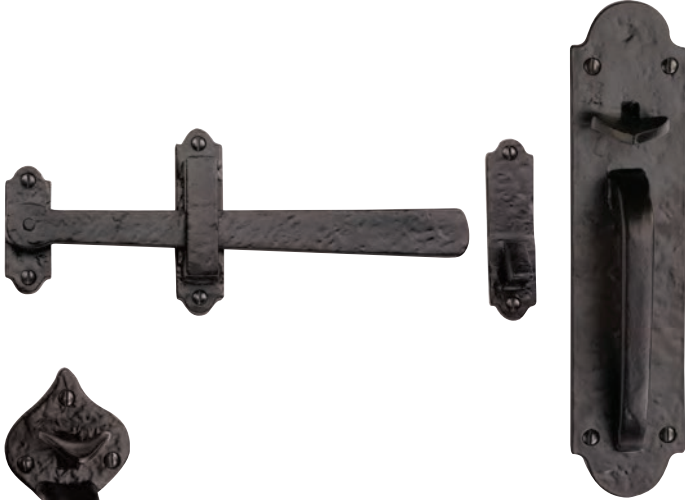

**TC569**  
Handle height: 227mm  
Handle width: 52mm  
Gate Latch length: 154mm



**TC169** Door Bolt Necked  
• 86mm  
• 106mm



**TC567**  
Handle height: 212mm  
Gate Latch length: 238mm



**TC158** Door Bolt Straight  
• 86mm  
• 106mm

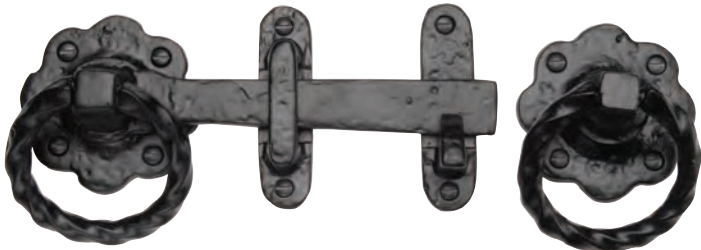

**TC543**  
Ring Handle diameter: 72mm  
Ring base diameter: 72mm  
Gate Latch length: 170mm

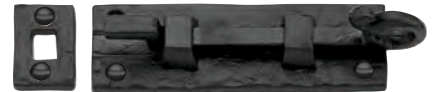

**TC159** Door Bolt Necked  
• 86mm  
• 106mm



**TC565** Suffolk Latch  
Handle height: 200mm  
Latch length: 150mm



**TC119**  
Door Stop  
3" 76mm



**TC153** Cabin Hook  
• 106mm  
• 153mm

HINGES

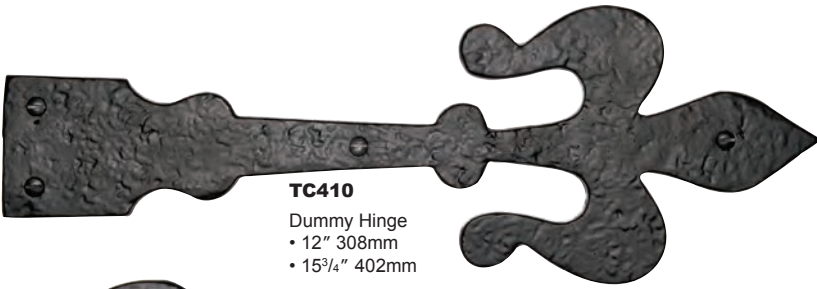

**TC410**  
 Dummy Hinge  
 • 12" 308mm  
 • 15 3/4" 402mm



**TC454**  
 W 128mm  
 H 91mm

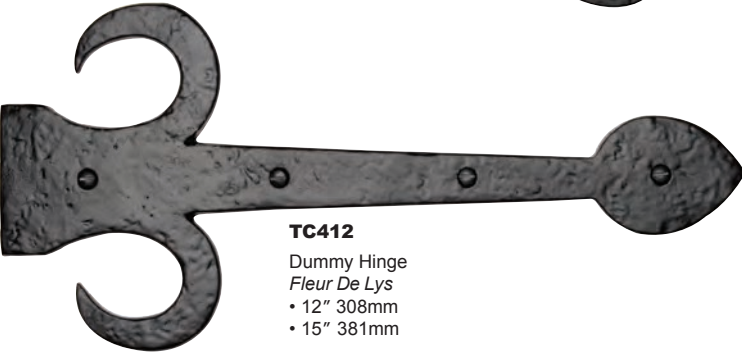

**TC412**  
 Dummy Hinge  
*Fleur De Lys*  
 • 12" 308mm  
 • 15" 381mm



**TC456**  
 W 80mm  
 H 78mm



**TC420**  
 Leaf Hinge  
 12" 308mm



**TC450**  
 Hinge  
 • 12" 308mm  
 • 15" 381mm  
 • 18" 457mm



**TC790**  
 Studs  
 • 40mm  
 • 19mm

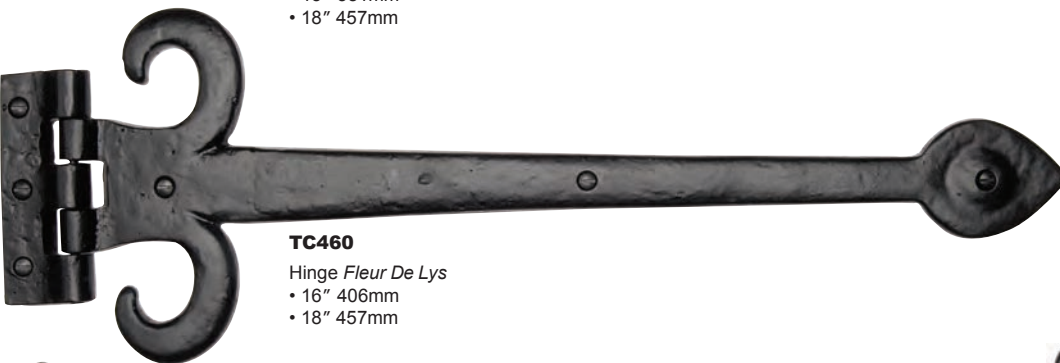

**TC460**  
 Hinge *Fleur De Lys*  
 • 16" 406mm  
 • 18" 457mm



**TC415**  
 Leaf Hinge  
 12 1/4" 307mm



**TC425**  
 Coronet Hinge 82mm

## HOOKS



**TC695**  
Coat Hook  
45mm



**TC697**  
Coat Hook  
102 x 49mm



**TC696**  
Hat & Coat Hook  
142 x 30mm



**TC670**  
Hat & Coat Hook  
152 x 45mm

## WINDOW HARDWARE



**TC675 MP/HP**  
Mortise and Hook plate  
118mm  
Casement Fastener



**TC490 MP/HP**  
Mortise and Hook plate  
128mm  
Casement Fastener



**TC580**  
Casement Stay  
• 10" 254mm  
• 12" 308mm



**TC380**  
Casement Stay  
• 10" 254mm  
• 12" 308mm



**TC480**  
Casement Stay  
• 10" 254mm  
• 12" 308mm

DOOR PULLS AND CABINET HARDWARE



**TC383**  
Pull handle  
•152mm  
•204mm



**TC3855**  
Pull handle  
128mm  
**TC3856**  
Pull handle  
175mm



**TC532**

Diameter	Projection
25	30
32	34
38	38



**TC534**

Diameter	Projection
32	32
38	35



**TC625**

Height	Width
85	56



**TC384**  
Pull Handle  
223 x 61mm



**TC386**  
Pull handle  
259 x 47mm



**TC458**

Height	Width
80	40
Ring Diameter 35	



**TC626**

Height	Width
65	61
Ring Diameter 65	



**TC549**

Height	Width
80	36



## *Electrical Accessories*

An extensive collection of Solid Brass Electrical Accessories in a wide range of finishes and styles that fully complements our door hardware offering to achieve an integrated overall look for any project undertaken. Full details of our extensive Electrical Accessories ranges can be found on our website, or by requesting a copy of our Electrical Accessories catalogue.

# STUDIO RANGE CONCEALED FIXING

Polished Brass Polished Chrome Satin Chrome Satin Nickel Antique Brass

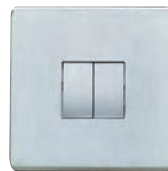

Box  
Depth

## 10 AMP Rocker Switches

	1 Gang 2 Way Switch	Y01.200.PB	Y02.200.PC	Y33.200.SC	Y05.200.SN	Y91.200.AB	25
	2 Gang 2 Way Switch	Y01.210.PB	Y02.210.PC	Y33.210.SC	Y05.210.SN	Y91.210.AB	25
	3 gang 2 Way Switch	Y01.220.PB	Y02.220.PC	Y33.220.SC	Y05.220.SN	Y91.220.AB	25
	4 gang 2 Way Switch	Y01.230.PB	Y02.230.PC	Y33.230.SC	Y05.230.SN	Y91.230.AB	35
	1 Gang Intermediate	Y01.201.PB	Y02.201.PC	Y33.201.SC	Y05.201.SN	Y91.201.AB	25

## 13 AMP Switched Sockets

	Single 13 AMP socket	Y01.240.PBW	Y02.240.PCW	Y33.240.SCW	Y05.240.SNW	Y91.240.ABBK	35
	Single 13 AMP socket	Y01.240.PBBK	Y02.240.PCBK	Y33.240.SCBK	Y05.240.SNBK		35
	Double 13 AMP socket	Y01.250.PBW	Y02.250.PCW	Y33.250.SCW	Y05.250.SNW	Y91.250.ABBK	35
	Double 13 AMP socket	Y01.250.PBBK	Y02.250.PCBK	Y33.250.SCBK	Y05.250.SNBK		35

## 13 AMP Fused Spur Units (Connection Units)

	Unswitched Spur	Y01.234.W	Y02.234.W	Y33.234.W	Y05.234.W	Y91.234.BK	35
	Unswitched Spur	Y01.234.BK	Y02.234.BK	Y33.234.BK	Y05.234.BK		35
	Switched Spur	Y01.235.PBW	Y02.235.PCW	Y33.235.SCW	Y05.235.SNW	Y91.235.ABBK	35
	Switched Spur	Y01.235.PBBK	Y02.235.PCBK	Y33.235.SCBK	Y05.235.SNBK		35
	Switched with neon	Y01.236.PBW	Y02.236.PCW	Y33.236.SCW	Y05.236.SNW	Y91.236.ABBK	35
	Switched with neon	Y01.236.PBBK	Y02.236.PCBK	Y33.236.SCBK	Y05.236.SNBK		35
	Switched with neon/cord	Y01.238.PBW	Y02.238.PCW	Y33.238.SCW	Y05.238.SNW	Y91.238.ABBK	35
	Switched with neon/cord	Y01.238.PBBK	Y02.238.PCBK	Y33.238.SCBK	Y05.238.SNBK		35

## 2 Way Dolly Switches

	1 gang dolly	Y01.2400.PB	Y02.2400.PC	Y33.2400.SC	Y05.2400.SN	Y91.2400.AB	35
	2 gang dolly	Y01.2410.PB	Y02.2410.PC	Y33.2410.SC	Y05.2410.SN	Y91.2410.AB	35
	3 gang dolly	Y01.2420.PB	Y02.2420.PC	Y33.2420.SC	Y05.2420.SN	Y91.2420.AB	35
	4 gang dolly	Y01.2430.PB	Y02.2430.PC	Y33.2430.SC	Y05.2430.SN	Y91.2430.AB	35
	1 gang Intermediate	Y01.2401.PB	Y02.2401.PC	Y33.2401.SC	Y05.2401.SN	Y91.2401.AB	35

## 2 Way Push On/Off Dimmer Switches

	1 gang dimmer (250 watts)	Y01.260/250	Y02.260/250	Y33.260/250	Y05.260/250	Y91.260/250	35
	1 gang dimmer (400 watts)	Y01.260/400	Y02.260/400	Y33.260/400	Y05.260/400	Y91.260/400	35
	2 gang dimmer (250 watts)	Y01.270/250	Y02.270/250	Y33.270/250	Y05.270/250	Y91.270/250	35
	2 gang dimmer (400 watts)	Y01.270/400	Y02.270/400	Y33.270/400	Y05.270/400	Y91.270/400	35
	3 gang dimmer (250 watts)	Y01.280/250	Y02.280/250	Y33.280/250	Y05.280/250	Y91.280/250	35
	3 gang dimmer (400 watts)	Y01.280/400	Y02.280/400	Y33.280/400	Y05.280/400	Y91.280/400	35
	4 gang dimmer (250 watts)	Y01.290/250	Y02.290/250	Y33.290/250	Y05.290/250	Y91.290/250	35
	4 gang dimmer (400 watts)	Y01.290/400	Y02.290/400	Y33.290/400	Y05.290/400	Y91.290/400	35

## Low Voltage Dimmer Switches

	1 gang Low Voltage 250VA	LVY01.260/250	LVY02.260/250	LVY33.260/250	LVY05.260/250	LVY91.260/250	35
	1 gang Low Voltage 400VA	LVY01.260/400	LVY02.260/400	LVY33.260/400	LVY05.260/400	LVY91.260/400	35
	2 gang Low Voltage 250VA	LVY01.270/250	LVY02.270/250	LVY33.270/250	LVY05.270/250	LVY91.270/250	35
	2 gang Low Voltage 400VA	LVY01.270/400	LVY02.270/400	LVY33.270/400	LVY05.270/400	LVY91.270/400	35
	3 gang Low Voltage 250VA	LVY01.280/250	LVY02.280/250	LVY33.280/250	LVY05.280/250	LVY91.280/250	35
	3 gang Low Voltage 400VA	LVY01.280/400	LVY02.280/400	LVY33.280/400	LVY05.280/400	LVY91.280/400	35

## 20 AMP D.P. Switches

	20 AMP D.P. Switch	Y01.205.PB	Y02.205.PC	Y33.205.SC	Y05.205.SN	Y91.205.AB	35
	20 AMP Switch with Neon	Y01.206.PB	Y02.206.PC	Y33.206.SC	Y05.206.SN	Y91.206.AB	35



# STUDIO RANGE CONCEALED FIXING

Polished Brass Polished Chrome Satin Chrome Satin Nickel Antique Brass



Box  
Depth

## 45 AMP Cooker Switches

	45 AMP Switch (single plate)	Y01.263.PB	Y02.263.PC	Y33.263.SC	Y05.263.SN	Y91.263.AB	48
	45 AMP cooker unit-13A socket white insert	Y01.262.PBW	Y02.262.PCW	Y33.262.SCW	Y05.262.SNW		48
	45 AMP cooker unit-13A socket black insert	Y01.262.PBBK	Y02.262.PCBK	Y33.262.SCBK	Y05.262.SNBK	Y91.262.ABBK	48

## Triple Pole Fan Isolating Switch

	6 AMP switch	Y01.2990.PB	Y02.2990.PC	Y33.2990.SC	Y05.2990.SN	Y91.2990.AB	25
--	--------------	-------------	-------------	-------------	-------------	-------------	----

## Round Pin Sockets Unswitched

	5 AMP 3 pin white insert	Y01.282.W	Y02.282.W	Y33.282.W	Y05.282.W		35
	5 AMP 3 pin black insert	Y01.282.BK	Y02.282.BK	Y33.282.BK	Y05.282.BK	Y91.282.BK	35

## Shaver Socket Dual Output

	Output voltage 110/240V white insert	Y01.285.W	Y02.285.W	Y33.285.W	Y05.285.W		55
	Output voltage 110/240V black insert	Y01.285.BK	Y02.285.BK	Y33.285.BK	Y05.285.BK	Y91.285.BK	55

## TV/Coaxial Sockets

	Single Non-Isolated white insert	Y01.221.W	Y02.221.W	Y33.221.W	Y05.221.W		35
	Single Non-Isolated black insert	Y01.221.BK	Y02.221.BK	Y33.221.BK	Y05.221.BK	Y91.221.BK	35
	Single Isolated white insert	Y01.223.W	Y02.223.W	Y33.223.W	Y05.223.W		35
	Single Isolated black insert	Y01.223.BK	Y02.223.BK	Y33.223.BK	Y05.223.BK	Y91.223.BK	35
	Twin Non-Isolated white insert	Y01.222.W	Y02.222.W	Y33.222.W	Y05.222.W		35
	Twin Non-Isolated black insert	Y01.222.BK	Y02.222.BK	Y33.222.BK	Y05.222.BK	Y91.222.BK	35
	TV/FM Duplexed white insert	Y01.224.W	Y02.224.W	Y33.224.W	Y05.224.W		35
	TV/FM Duplexed black insert	Y01.224.BK	Y02.224.BK	Y33.224.BK	Y05.224.BK	Y91.224.BK	35

## Satellite Sockets

	Satellite Socket white insert	Y01.225.W	Y02.225.W	Y33.225.W	Y05.225.W		35
	Satellite Socket black insert	Y01.225.BK	Y02.225.BK	Y33.225.BK	Y05.225.BK	Y91.225.BK	35
	TV/Satellite Socket white insert	Y01.226.W	Y02.226.W	Y33.226.W	Y05.226.W		35
	TV/Satellite Socket black insert	Y01.226.BK	Y02.226.BK	Y33.226.BK	Y05.226.BK	Y91.226.BK	35

## Telephone and Data Sockets

	1 Gang Secondary Line white insert	Y01.266.W	Y02.266.W	Y33.266.W	Y05.266.W		35
	1 Gang Secondary Line black insert	Y01.266.BK	Y02.266.BK	Y33.266.BK	Y05.266.BK	Y91.266.BK	35
	1 Gang Master Line white insert	Y01.267.W	Y02.267.W	Y33.267.W	Y05.267.W		35
	1 Gang Master Line black insert	Y01.267.BK	Y02.267.BK	Y33.267.BK	Y05.267.BK	Y91.267.BK	35
	2 Gang Secondary line white Insert	Y01.256.W	Y02.256.W	Y33.256.W	Y05.256.W		35
	2 Gang Secondary line black Insert	Y01.256.BK	Y02.256.BK	Y33.256.BK	Y05.256.BK	Y91.256.BK	35
	2 Gang Master line white Insert	Y01.257.W	Y02.257.W	Y33.257.W	Y05.257.W		35
	2 Gang Master line black Insert	Y01.257.BK	Y02.257.BK	Y33.257.BK	Y05.257.BK	Y91.257.BK	35
	1 Gang RJ45 white Insert	Y01.268.W	Y02.268.W	Y33.268.W	Y05.268.W		35
	1 Gang RJ45 black Insert	Y01.268.BK	Y02.268.BK	Y33.268.BK	Y05.268.BK	Y91.268.BK	35
	1 Gang RJ11 white Insert	Y01.269.W	Y02.269.W	Y33.269.W	Y05.269.W		35
	1 Gang RJ11 black Insert	Y01.269.BK	Y02.269.BK	Y33.269.BK	Y05.269.BK	Y91.269.BK	35
	2 Gang RJ45 white Insert	Y01.258.W	Y02.258.W	Y33.258.W	Y05.258.W		35
	2 Gang RJ45 black Insert	Y01.258.BK	Y02.258.BK	Y33.258.BK	Y05.258.BK	Y91.258.BK	35

## Blanking Plates

	Single Section Blank Plate	Y01.231	Y02.231	Y33.231	Y05.231	Y91.231	~
	Double Section Blank Plate	Y01.232	Y02.232	Y33.232	Y05.232	Y91.232	~



## *Nightlatches*

Our range of nightlatches with modern styling are available in a variety of finishes, including Antique and Matt Bronze finish to complement our other door hardware offerings and to achieve an integrated overall look for any project undertaken.



## *Locks and Latches*

A comprehensive array of locks and latches, available in our full complement of finishes to match your door hardware. This image is for illustrative purposes only. Please see following pages for details and product profile.

## LOCKS AND LATCHES

Colour of lock cases may change

### STANDARD DUTY TUBULAR LATCHES

#### Bolt Through

<b>YKTL2-AT</b>	2 1/2" Antique Finish
<b>YKTL2-BLK</b>	2 1/2" Black Finish
<b>YKTL2-MB</b>	2 1/2" Matt Bronze Finish
<b>YKTL2-PB</b>	2 1/2" Brass Finish
<b>YKTL2-PC&amp;PN</b>	2 1/2" Pol.Chrome/Nickel Finish
<b>YKTL2-SB</b>	2 1/2" Satin Brass Finish
<b>YKTL2-SN&amp;SC</b>	2 1/2" Satin Chrome/Nickel Finish
<b>YKTL3-AT</b>	3" Antique Finish
<b>YKTL3-BLK</b>	3" Black Finish
<b>YKTL3-MB</b>	3" Matt Bronze Finish
<b>YKTL3-PB</b>	3" Brass Finish
<b>YKTL3PC&amp;PN</b>	3" Pol.Chrome/Nickel Finish
<b>YKTL3-SB</b>	3" Satin Brass Finish
<b>YKTL3-SN&amp;SC</b>	3" Satin Chrome/Nickel Finish

#### REBATE KITS TO SUIT (Standard Latch Only)

<b>YKRBTL-AT</b>	Rebate For YKTL Antique Brass
<b>YKRBTL-MB</b>	Rebate For YKTL Matt Bronze
<b>YKRBTL-PB</b>	Rebate For YKTL Polished Brass
<b>YKRBTL-PC</b>	Rebate For YKTL Polished Chrome
<b>YKRBTL-PNF</b>	Rebate For YKTL Polished Nickel
<b>YKRBTL-SB</b>	Rebate For YKTL Satin Brass
<b>YKRBTL-SC</b>	Rebate For YKTL Satin Chrome
<b>YKRBTL-SN</b>	Rebate For YKTL Satin Nickel

### HEAVY DUTY TUBULAR LATCHES

<b>YKAL2-AT</b>	2 1/2" NOT Bolt Through Antique Finish
<b>YKAL2-BLK</b>	2 1/2" NOT Bolt Through Black Finish
<b>YKAL2-MB</b>	2 1/2" NOT Bolt Through Matt Bronze Finish
<b>YKAL2-PB</b>	2 1/2" NOT Bolt Through Polished Brass Finish
<b>YKAL2-PC&amp;PN</b>	2 1/2" NOT Bolt Through Pol.Chrome/Nickel Finish
<b>YKAL2-SB</b>	2 1/2" NOT Bolt Through Satin Brass Finish
<b>YKAL2-SN&amp;SC</b>	2 1/2" NOT Bolt Through Satin Nickel Finish
<b>YKAL3-AT</b>	3" Bolt Through Antique Finish
<b>YKAL3-BLK</b>	3" Bolt Through Black Finish
<b>YKAL3-MB</b>	3" Bolt Through Matt Bronze Finish
<b>YKAL3-PB</b>	3" Bolt Through Polished Brass Finish
<b>YKAL3-PC&amp;PN</b>	3" Bolt Through Pol.Chrome/Nickel Finish
<b>YKAL3-SB</b>	3" Bolt Through Satin Brass Finish
<b>YKAL3-SN&amp;SC</b>	3" Bolt Through Satin Chrome/Nickel Finish
<b>YKAL4-AT</b>	4" Bolt Through Antique Finish
<b>YKAL4-BLK</b>	4" Bolt Through Black Finish
<b>YKAL4-MB</b>	4" Bolt Through Matt Bronze Finish
<b>YKAL4-PB</b>	4" Bolt Through Polished Brass Finish
<b>YKAL4-PC&amp;PN</b>	4" Bolt Through Pol.Chrome/Nickel Finish
<b>YKAL4-SB</b>	4" Bolt Through Satin Brass Finish
<b>YKAL4-SN&amp;SC</b>	4" Bolt Through Satin Chrome/Nickel Finish
<b>YKAL5-AT</b>	5" Bolt Through Antique Finish
<b>YKAL5-BLK</b>	5" Bolt Through Black Finish
<b>YKAL5-MB</b>	5" Bolt Through Matt Bronze Finish
<b>YKAL5-PB</b>	5" Bolt Through Polished Brass Finish
<b>YKAL5-PC&amp;PN</b>	5" Bolt Through Pol.Chrome/Nickel Finish
<b>YKAL5-SB</b>	5" Bolt Through Satin Brass Finish
<b>YKAL5-SN&amp;SC</b>	5" Bolt Through Satin Chrome/Nickel Finish

### TUBULAR BATHROOM DEADBOLT

<b>YKBDB3-AT</b>	3" Antique Finish
<b>YKBDB3-BLK</b>	3" Black Finish
<b>YKBDB3-MB</b>	3" Matt Bronze Finish
<b>YKBDB3-PB</b>	3" Polished Brass Finish
<b>YKBDB3-PC&amp;PN</b>	3" Pol.Chrome/Nickel Finish
<b>YKBDB3-SB</b>	3" Satin Brass Finish
<b>YKBDB3-SN&amp;SC</b>	3" Satin Chrome/Nickel Finish
<b>YKBDB4-AT</b>	4" Antique Finish
<b>YKBDB4-BLK</b>	4" Black Finish
<b>YKBDB4-MB</b>	4" Matt Bronze Finish
<b>YKBDB4-PB</b>	4" Polished Brass Finish
<b>YKBDB4-PC&amp;PN</b>	4" Pol.Chrome/Nickel Finish
<b>YKBDB4-SB</b>	4" Satin Brass Finish
<b>YKBDB4-SN&amp;SC</b>	4" Satin Chrome/Nickel Finish

Lengths available: 2 1/2" & 3"

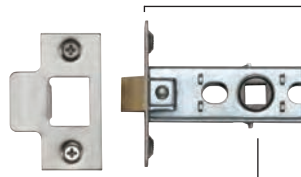

Backset: 44 & 57mm

#### Description

- Lightly sprung latch.
  - Used for internal doors that do not require locking from either side.
  - Suitable for sprung levers and sprung mortice knobs.
  - Suitable for use with 8mm door handle spindles and for round rose furniture requiring bolt through fixing.
  - Latch is fully reversible for door handing.
- 2 1/2" recommended for Levers  
3" recommended for sprung Mortice Knobs  
(Not recommended for unsprung Mortice Knobs)*

#### Description

- Heavy duty strongly sprung latch.
  - Used for internal doors that do not require locking.
  - Suitable for unsprung levers, unsprung mortice knobs and with heavy lever handles requiring additional springing to return to rest.
  - Suitable for use with 8mm door handle spindles and for round rose furniture requiring bolt through fixing (except 2 1/2").
  - Includes dust box for strike plate.
  - Latch bolt easily reversed for door handing by turning latch bolt.
- 2 1/2" recommended for Levers  
3" recommended for unsprung Mortice Knobs  
(Not recommended for sprung Mortice Knobs)*

Lengths available:  
2 1/2", 3", 4", & 5"

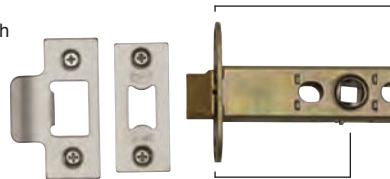

Backset :  
44, 57, 82, & 107mm

#### Description

- Used for internal doors where privacy is required. A thumbturn and release is required to operate the bolt.
- Door is locked & unlocked by throwing the bolt. In emergencies the bolt may be thrown using a coin release from outside.
- Suitable for use with 5mm thumbturn & emergency release spindles and for thumbturns requiring bolt through fixing.
- Includes dust box for strike plate.
- Bolt is fully reversible for door handing & suitable for thumbturns that require bolt through fixing.

Lengths available: 3" & 4"

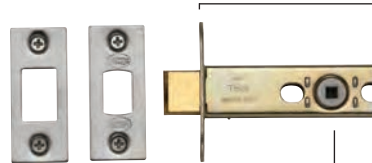

Backset: 57 & 82mm

# LOCKS AND LATCHES

Colour of lock cases may change

## BATHROOM LOCKS Bolt Through

CODE	Code Previously	
<b>YKABL2-AT</b>	YKBL2	2 1/2" Antique Finish
<b>YKABL2-BLK</b>	YKBL2	2 1/2" Black Finish
<b>YKABL2-MB</b>	YKBL2	2 1/2" Matt Bronze Finish
<b>YKABL2-PB</b>	YKBL2	2 1/2" Brass Finish
<b>YKABL2-PC&amp;PN</b>	YKBL2	2 1/2" Pol.Chrome/Nickel Finish
<b>YKABL2-SB</b>	YKBL2	2 1/2" Satin Brass Finish
<b>YKABL2-SN&amp;SC</b>	YKBL2	2 1/2" Satin Chrome/Nickel Finish
<b>YKABL3-AT</b>	YKBL3	3" Antique Finish
<b>YKABL3-BLK</b>	YKBL3	3" Black Finish
<b>YKABL3-MB</b>	YKBL3	3" Matt Bronze Finish
<b>YKABL3-PB</b>	YKBL3	3" Brass Finish
<b>YKABL3-PC&amp;PN</b>	YKBL3	3" Pol.Chrome/Nickel Finish
<b>YKABL3-SB</b>	YKBL3	3" Satin Brass Finish
<b>YKABL3-SN&amp;SC</b>	YKBL3	3" Satin Chrome/Nickel Finish

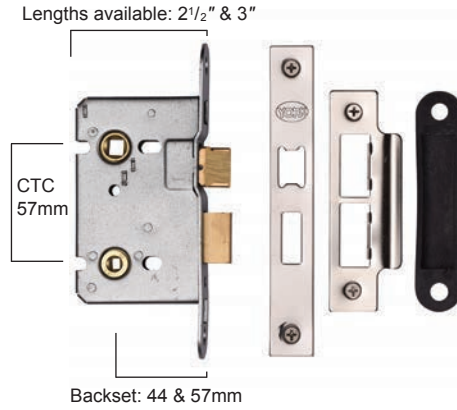

### Description

- For internal doors where privacy is required.
- Suitable for use with bathroom door handles with 8mm spindles and 57mm centres (CTC).
- Also suitable for use with lever on rose handles requiring bolt through fixing or with door knobs, latch is fully reversible for door handing.
- When using lever on rose handles or door knobs use with separate Thumbturn & Release.
- Includes dust box for strike.
- Easily reversed for door handing without opening lock by turning latch bolt.

## 3 LEVER SASHLOCKS Bolt Through

CODE	Code Previously	
<b>YKASL32-AT</b>	YKSL32	2 1/2" Antique Finish
<b>YKASL32-BLK</b>	YKSL32	2 1/2" Black Finish
<b>YKASL32-MB</b>	YKSL32	2 1/2" Matt Bronze Finish
<b>YKASL32-PB</b>	YKSL32	2 1/2" Brass Finish
<b>YKASL32-PC&amp;PN</b>	YKSL32	2 1/2" Pol.Chrome/Nickel Finish
<b>YKASL32-SB</b>	YKSL32	2 1/2" Satin Brass Finish
<b>YKASL32-SN&amp;SC</b>	YKSL32	2 1/2" Satin Chrome/Nickel Finish
<b>YKASL33-AT</b>	YKSL33	3" Antique Finish
<b>YKASL33-BLK</b>	YKSL33	3" Black Finish
<b>YKASL33-MB</b>	YKSL33	3" Matt Bronze Finish
<b>YKASL33-PB</b>	YKSL33	3" Brass Finish
<b>YKASL33-PC&amp;PN</b>	YKSL33	3" Pol.Chrome/Nickel Finish
<b>YKASL33-SB</b>	YKSL33	3" Satin Brass Finish
<b>YKASL33-SN&amp;SC</b>	YKSL33	3" Satin Chrome/Nickel Finish

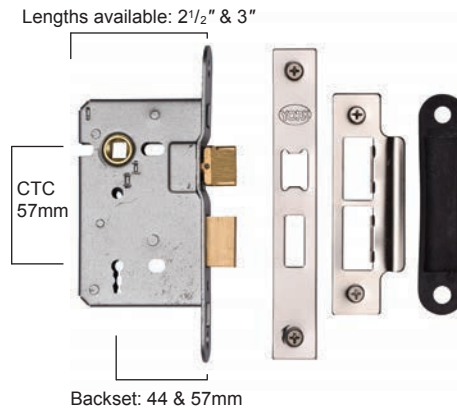

### Description

- For internal doors which need to be latched and locked.
- Suitable for use with lever lock door handles with 8mm spindles and 57mm centres (CTC)
- Also suitable for use with lever on rose handles requiring bolt through fixing or with door knobs.
- Includes dust box for strike.
- Easily reversed for door handing without opening lock by turning latch bolt.

## EUROPROFILE SASHLOCKS

<b>YKASLE2-AT</b>	2 1/2" Antique Finish
<b>YKASLE2-BLK</b>	2 1/2" Black Finish
<b>YKASLE2-MB</b>	2 1/2" Matt Bronze Finish
<b>YKASLE2-PB</b>	2 1/2" Brass Finish
<b>YKASLE2-PC&amp;PN</b>	2 1/2" Pol.Chrome/Nickel Finish
<b>YKASLE2-SB</b>	2 1/2" Satin Brass Finish
<b>YKASLE2-SN&amp;SC</b>	2 1/2" Satin Chrome/Nickel Finish
<b>YKASLE3-AT</b>	3" Antique Finish
<b>YKASLE2-BLK</b>	3" Black Finish
<b>YKASLE3-MB</b>	3" Matt Bronze Finish
<b>YKASLE3-PB</b>	3" Brass Finish
<b>YKASLE3-PC&amp;PN</b>	3" Pol.Chrome/Nickel Finish
<b>YKASLE3-SB</b>	3" Satin Brass Finish
<b>YKASLE3-SN&amp;SC</b>	3" Satin Chrome/Nickel Finish

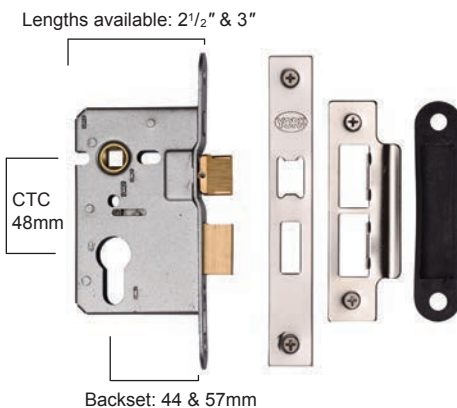

### Description

- For internal or external doors which require to be latched and locked using a Euro Profile cylinder.
- Suitable for use with Euro Profile door handles with 8mm spindles and 48mm centres (CTC).
- Suitable for Lever on rose handles requiring bolt through fixing.
- An Iso Euro Profile cylinder or similar will be required to operate the bolt.
- Includes dust box for strike.
- Easily reversed for door handing without opening lock by turning latch bolt.

## LOCKS AND LATCHES

Colour of lock cases may change

### BRITISH STANDARD 5 LEVER SASHLOCKS

- YK BSSL27** 2 1/2" Brass Finish
- YK BSSL29** 2 1/2" Satin Finish
- YK BSSL37** 3" Brass Finish
- YK BSSL39** 3" Satin Finish

### REBATE KITS TO SUIT

- YKRB BSSL7.5** 1/2" Brass Finish
- YKRB BSSL9.5** 1/2" Satin Finish
- YKRB BSSL7.1** 1" Brass Finish
- YKRB BSSL9.1** 1" Satin Finish

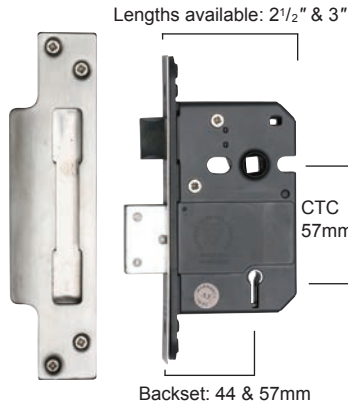

### Description

- For external doors which require secure locking using a kitemarked BS 3621 approved mortice lock.
- Suitable for use with lever lock handles with 8mm spindles and 57mm centres (CTC).
- Also suitable for use with lever on rose handles requiring bolt through fixing. Includes fixing guide template & dust box for strike.
- Easily reversed for door handing without opening lock by turning latch bolt.

### BRITISH STANDARD 5 LEVER DEADLOCKS

- YK BSDL27** 2 1/2" Brass Finish
- YK BSDL29** 2 1/2" Satin Finish
- YK BSDL37** 3" Brass Finish
- YK BSDL39** 3" Satin Finish

### REBATE KITS TO SUIT

- YKRB BSDL7.5** 1/2" Brass Finish
- YKRB BSDL9.5** 1/2" Satin Finish
- YKRB BSDL7.1** 1" Brass Finish
- YKRB BSDL9.1** 1" Satin Finish



### Description

- For external doors which require secure locking using a kitemarked BS 3621 approved mortice lock.
- Provides added security when fitted in conjunction with nightlatches
- Includes fixing guide template & dust box for strike.

## NIGHTLATCHES



### NIGHTLATCHES 60mm

- NL3060-AT** 60mm Antique Finish
- NL3060-PB** 60mm Polished Brass
- NL3060-PC** 60mm Polished Chrome
- NL3060-MB** 60mm Matt Bronze Finish
- NL3060-SC** 60mm Satin Chrome Finish
- NL3060-WH** 60mm White Finish
- NL3060-BLK** 60mm Black Finish

### REPLACEMENT RIM CYLINDERS

- NLCYL PB** Polished Brass Finish
- NLCYL PC** Polished Chrome Finish

### NIGHTLATCHES 40mm

- NL3040-AT** 40mm Antique Finish
- NL3040-PB** 40mm Polished Brass
- NL3040-PC** 40mm Polished Chrome
- NL3040-MB** 40mm Matt Bronze Finish
- NL3040-SC** 40mm Satin Chrome Finish
- NL3040-WH** 40mm White Finish
- NL3040-BLK** 40mm Black Finish

### ROLLER BOLT NIGHTLATCHES

- NL-R3060-AT** 60mm Antique Finish
- NL-R3060-PB** 60mm Polished Brass
- NL-R3060-PC** 60mm Polished Chrome
- NL-R3060-MB** 60mm Matt Bronze Finish
- NL-R3060-SC** 60mm Satin Chrome Finish
- NL-R3060-WH** 60mm White Finish
- NL-R3060-BLK** 60mm Black Finish

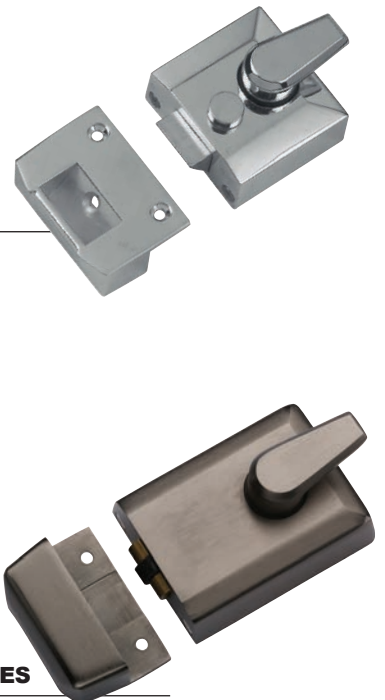

## AGED FINISHES

We have added 5 new finishes to our already extensive product range.

### **MATT Bronze**

Polished Brass which is not lacquered will naturally darken with time, however with our MATT Bronze finish we have aged the brass, and applied a clear lacquer.

Over a period of time the bronze colour will lighten along any edges and surfaces that are frequently touched and create a naturally aged appearance highlighting frequently touched areas and exposing the brass below.

As the finish will change over time, there is no warranty on this finish.

### **Antique Brass**

With this finish we polish the brass and apply a bronze patina over the total surface.

Using soft brushes our experienced polishers remove some of the bronze patina to expose the brass below thus highlighting the variance of shades making each piece both appealing and unique.

To preserve the final appearance, we apply a protective coating of clear electrophoretic lacquer.

### **Polished Nickel, a Living Finish**

Our Polished Nickel finish is nickel plating on highly polished brass.

The nickel finish is not coated and will therefore oxidise naturally.

If not regularly buffed with a soft cloth the nickel plate will subtly change over time by taking on an aged patina.

### **Solid Bronze Rustic, a Living Finish**

These striking products are made using molten Bronze flowing into cavities within a sand mould. This casting process leaves light surface indentations to bestow a rustic appearance, which contrasts in texture to other smoothly finished products. A light bronze patina is applied by hand on the cast bronze creating a country-style appearance.

When leaving the factory these products are coated with paste wax. This acts as a barrier to prevent oxygen from immediately oxidizing the bronze surface. Over time, this layer is worn away allowing water and oxygen to then oxidise the surface.

Over a period of time the bronze patina will lighten along any edges and surfaces that are frequently touched, creating a naturally aged appearance as the bronze below is exposed. When untouched the finish may darken as the bronze oxidises.

As this is a living finish, products will not be identical, there will be slight variation in hue and tone.

Avoid exposure to abrasives or chemicals as these will mar the surface finish.

It is good practice to occasionally wax the surface using Carnauba wax.

As the finish will change over time, there is no warranty on this finish.

### **Black Iron Rustic**

Our Black Rustic range is produced with molten iron flowing into cavities in a sand mould and made malleable by a process known as annealing. The surface of this product will reveal slight indentations created as the metal cools while the shape is being formed to bestow an aged look.

After casting we treat the iron with a process called Phosphating, which slows the rusting process, and coat the product with a powder coated black finish.

Any Iron product is prone to rusting, please read our maintenance recommendations.

## PRODUCT CARE

Maintaining the quality of the finish requires occasional care by removing dust and stains from the surfaces.

### **Lacquered Finishes**

Comprising Polished Brass, Satin Nickel, Antique Brass, Matt Bronze, Satin Brass, Jupiter, Mercury and Mayfair.

All lacquered finishes will eventually break down over time. Lacquer breakdown will occur more frequently on products exposed to the climate, particularly in coastal areas and in polluted environments.

Regularly removing dirt and watermarks with a non-abrasive cloth will help maintain the life of this finish.

For products used externally applying a non-abrasive light wax coating will protect the lacquer and could extend its life. DO NOT USE metal cleaners or aerosol sprays as these will damage the lacquer.

External fittings will also benefit from a periodic light oiling of springs and moving parts

The life of the lacquer is beyond the manufacturer's control, and therefore cannot be guaranteed.

### **Polished Chrome, Satin Chrome, Apollo and PVD Finishes**

Regularly removing dirt and watermarks with a nonabrasive cloth will help maintain the life of these finishes.

External fittings will also benefit from a periodic light oiling of springs and moving parts

### **Black Iron Door Furniture**

Regularly removing dirt and watermarks with a non-abrasive cloth will help maintain the life of this finish.

Exposure to humidity will cause the product to rust so all external fittings will benefit from an occasional wiping over with a lightly oiled cloth and a periodic light oiling of springs and moving parts.

If the decorative material shows signs of 'Chipping' remove any flaking or loose paint, making sure the surface is dry and grease free, then spot the affected area with enamel paint e.g. 'Humbrol' or similar.

## FREQUENTLY ASKED QUESTIONS

### Year of Establishment

We were established in April 1940.

### M. Marcus and Heritage Brass

M. Marcus started selling products under the brand name of Heritage Brass in the 1980's so we are now also known as Heritage Brass.

### Quality of Brass

All our Heritage Brass door furniture is created using hot forged brass which ensures the best manufacturing process for both strength and superior finish.

### Durability of Springs

The springs used are crucial to prevent breakages so we source our door furniture springs from a long established Italian manufacturer. Our springs have been cycle tested to provide 100,000 lever operations, and for residential use we offer a 10 year mechanism warranty.

### Locks and Latches

Our handles are not supplied with locks, latches or escutcheons. These items need to be purchased separately for the specific function required. Our lock ranges are shown on pages 105-107.

### Door Thickness

The spindles we supply as standard with our door furniture will in most cases be suitable for common domestic door thicknesses in the range of 35 to 44mm without having to be cut down. However as door thicknesses may be greater we can supply to special order longer spindles for doors of 50mm and upwards.

### Fixing of Round Rose Door Furniture

On levers where both woodscrews and bolts are supplied, we highly recommend that the bolts are used to securely clamp the handles to the door and not the woodscrews, as with just the woodscrews the handles will not be secured sufficiently on the door. The woodscrews are only to be used as an additional means to limit any tendency of the inner roses to rotate once fitted.

We reserve the right to amend products & sizes without notice and all dimensions provided are approximate. Colours shown in this catalogue may vary slightly from actual product due to photographic and colour reproduction. All errors and omissions excepted. Antique and Bronze finishes have variations in tone and colour, this is not a fault but a characteristic of the finish, so finish matches cannot be guaranteed.

## Accreditations

M. Marcus Ltd. is an:  
ISO 9001:2015 & ISO 14001:2015 accredited company.



Certificate No. FM 35735  
ISO 9001:2015



Certificate No. EMS 572656  
ISO 14001:2015

## Trade Association Membership



Guild of Architectural Ironmongers



Master Locksmiths Association



British Independent Retailers Association



National Merchant Buying Society



ths Tools Group

## WARRANTIES

### Warranties for Door Hardware

These warranties are offered in addition to any statutory legal rights for the sale of goods.

M. Marcus will not be liable for any incidental or consequential damages arising from the sale or use of our products. We assume no liability for any labour charges regarding the removal or reinstallation of the products; nor will we cover any carriage costs. Our only obligation will be to replace any defective products.

For terms and conditions of sale please refer to our current retail price list.

### 10 Year Mechanism Warranty

Sprung sets will be replaced if within 10 years from the date of purchase the spring mechanism breaks due to faulty workmanship or materials. The warranty is made void by any breakage which in the manufacturer's opinion arises from misuse or lack of maintenance. To validate any claim under this warranty a receipt or other proof of the age of the installation may be requested.

### Everbrite: 10 Year Finish Warranty

Our 'Everbrite' branded products will be replaced if within 10 years from the date of purchase the decorative finish discolours due to faulty workmanship or materials. This warranty applies only to the original purchaser. The warranty is made void for any discolouration which in the manufacturer's opinion arises from misuse or lack of maintenance. To validate any claim under this warranty a receipt or other proof of the age of the installation may be requested.

### Warranties for Electrical Accessories

These warranties are offered in addition to any statutory legal rights for the sale of goods.

Heritage Brass Electrical Accessories are guaranteed for 5 years (dimmer switches 1 year) provided the following conditions are met.

- 1) The accessory has been properly installed complete with its protective gasket by a qualified electrician in accordance with the wiring regulations current at the time of installation.
- 2) The accessory has been subjected to normal use and has not been altered or dismantled in any way.





# SORRENTO

ITALIAN STYLED LEVER HANDLES  
Made from Zinc Alloy



# ISEO

 Cylinders

Made in Italy



# Heritage Brass

ELECTRICAL ACCESSORIES



# ISEO

 Panic Exit Devices

## FLUSH HANDLE LOCK SETS FOR SLIDING PRIVACY DOORS



Please visit [www.m-marcus.com](http://www.m-marcus.com) to see the full range  
RD2308-40-SB Made in Italy



Signac Collection

Heritage Brass  
SOLID-BRASS DOOR FURNITURE

Please visit [www.m-marcus.com](http://www.m-marcus.com) to see the full range

August 2021

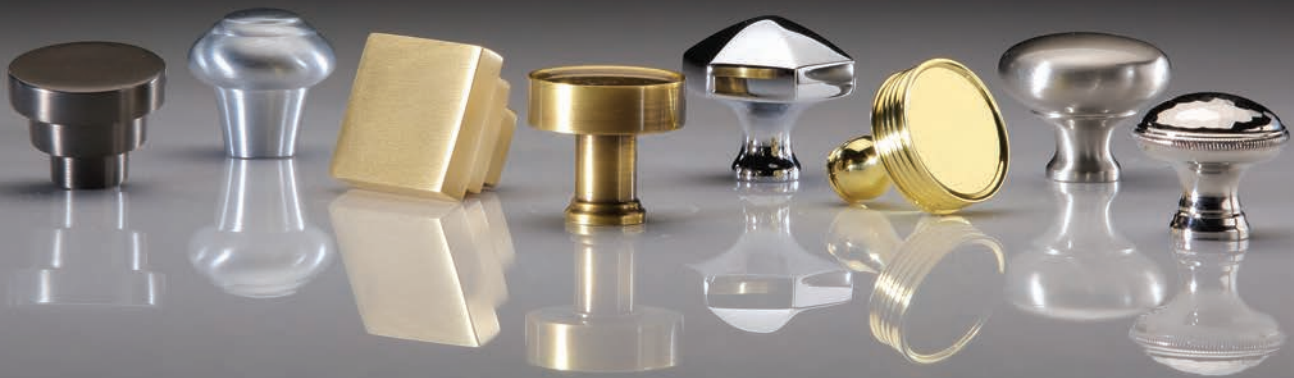

m.marcus

architectural hardware

**M. Marcus Ltd.** Unit 7, Narrowboat Way, Dudley, DY2 0XQ  
Admin Tel: (01384) 457900

Hardware Sales Tel: (01384) 247844 Hardware Sales Fax: (01384) 242252  
Hardware Sales e-mail: sales@m-marcus.com

Electrical Sales Tel: (01384) 247845 - Electrical Sales Fax: (01384) 243312  
Electrical Sales e-mail: electsales@m-marcus.com

Iseo Sales Tel: (01384) 247833 - Iseo Sales Fax: (01384) 253687  
Iseo Sales e-mail: iseosales@m-marcus.com

Our Website: <http://www.m-marcus.com>